

Report

Do not forget to **adopt and follow strictly** the **International System of Units** conventions in your report.

Acknowledgment

First of all we would like to thank ISEP and Nídia Sá Caetano for giving us an opportunity to perform this project and again extra thanks to Nídia for all her help and patience. We would also like to express our gratitude towards all the supervisors: Maria Benedita Malheiro, Manuel Santos Silva, António Ferreira da Silva, Maria Cristina Ribeiro, Paulo Ferreira and Pedro Barbosa Guedes who were a great help while dealing with all problems occurring during the semester. We would also like to give special thanks to Joao Fransisco Silva who helped us with the parts assembling. Thank you also Ana Barata for leading us with writing all of the deliverables.

Abstract

Nowadays, excessive fuel consumption has become a serious problem. People are searching for new solutions of power production. Fortunately, there are several options on how to obtain sources of energy without devastating already destroyed environment. One of these solutions is growing microalgae, from which biodiesel can be obtained. This report presents steps to create the device to harvest the algae by drying them with the usage of solar energy. Such alternative to already existing methods is competitive as far as energy usage is concerned. Working on microalgae lets us feel that we may contribute to the broad field of biodiesel derivation investigation. The solar algae dryer is a distiller that gets rid of the unnecessary water from the algae solution. This report describes what kind of technologies, materials and equipment were used in order to build the solar algae dryer prototype. It also presents the device from ethical and sustainable point of view. The marketing plan for product commercialization and possible future enhancements are also described.

Glossary

Microalgae: a vast group of photosynthetic, heterotrophic organisms which have an extraordinary potential for cultivation as energy crops

Biodiesel: a vegetable oil- or animal fat-based diesel fuel consisting of long-chain alkyl (methyl, propyl or ethyl) esters.

Bioremediation: the use of micro organismal metabolism to remove pollutants.

Nutrient: a chemical that an organism needs to live and grow or a substance used in an organism's metabolism which must be taken in from its environment.

UV radiation: light is electromagnetic radiation with a wavelength shorter than that of visible light, but longer than X-rays, in the range 10 nm to 400 nm, and energies from 3eV to 124 eV.

Deontology: branch dealing with duty, moral obligation, and right action.

Decree: a formal and authoritative order, especially one having the force of law.

Community: a social group of any size whose members reside in a specific locality, share government, and often have a common cultural and historical heritage.

Liabe: legally responsible.

Sensor: is a converter that measures a physical quantity and converts it into a signal which can be read by an observer or by an instrument.

Capacitor: is a passive two-terminal electrical component used to store energy in an electric field.

Community: a social group of any size whose members reside in a specific locality, share government, and often have a common cultural and historical heritage.

Deontology: branch dealing with duty, moral obligation, and right action.

Decree: a formal and authoritative order, especially one having the force of law.

EPS: European Project Semester

ISEP: Instituto Superior de Engenharia do Porto

LED: Light-Emitting Diode

Liabe: legally responsible.

Microalgae: a vast group of photosynthetic, heterotrophic organisms, which have an extraordinary potential for cultivation as energy crops

Nutrient: a chemical that an organism needs to live and grow or a substance used in an organism's metabolism, which must be taken in from its environment.

Sensor: is a converter that measures a physical quantity and converts it into a signal which can be read by an observer or by an instrument.

SWOT: Strength Weakness Opportunity Threat

USP: Unique Selling Point





UV radiation: electromagnetic radiation with a wavelength shorter than that of visible light, but longer than X-rays, in the range 10 nm to 400 nm.

1. Introduction

1.1. Team

We are an intercultural team of students which is doing the European project semester on the Instituto de Engenharia do Porto, our team consists of:

Table 1. Team members

	<ul style="list-style-type: none"> • Aleksandra Brygider • Mechanical Engineering and Computer Science • Poland
	<ul style="list-style-type: none"> • Sven Petersen • International Purchases and Sales Engineering • Germany
	<ul style="list-style-type: none"> • Paul Ahlskog • Industrial Management and Engineering • Finland
	<ul style="list-style-type: none"> • Benedicte Verbraeken • Industrial Design • Belgium
	<ul style="list-style-type: none"> • Bartłomiej Marciniak • Mechanical Engineering and Computer Science • Poland

1.2. Problem

The problem we were presented was how to dry microalgae solution using solar energy. Even though there are plenty of methods of algae drying, only some of them introduce sun radiation into the process. Hence, our idea was to create a distiller that would incorporate direct and indirect solar radiation, making use of a solar panel. We thought of prototyping solar algae dryer that would be competitive to already existing devices.

1.3. Motivation

From the start we were drawn to the projects that dealt with solar power and had eco-friendly feature. What attracted us the most to the solar dryer was the fact that it is a project that might help in the bio diesel development. At present high use of fossil fuels is one of our biggest contemporary problems. The solar dryer is going to be developed for the Chemical Engineering Department at our school. For us that was another advantage. So we chose this project because we want to be a part in the search for a more ecologically friendly alternative than fossil fuel is. The fuel that has been used so far is limited and it is polluting the earth.

1.4. Objectives

The main objective of the work is to create a device to dry microalgae that uses solar power to be operated. It must have a safety system that hinders it from working if the temperature exceeds 50°C. The reason for that is the fact that algal biomass, for instance oil or pigments, so what we would like to get after drying, may easily get spoiled in elevated temperatures. This problem is elaborated in details in further part of this report. Other aspect is that the whole process has to be finished in one day. Our idea is to develop a dryer that uses small amount of power.

1.5. Expected Results

We expect that the Solar Dryer will fulfill the clients needs which are drying algae with the use of solar power. We expect it to dry the algae to less then 10 % humidity in 24 hours. We also expect our algae-dryer to be one of the most energy efficient in the market.

1.6. Product planning

Regarding the work plan we divided our task into three modules. The general milestones together with a start and end date for every task are located in the Gantt chart shown in Figure 2. Furthermore, we allocated each task to the team members, which is represented in the task allocation shown in Table 2. Finally, every task is specified and defined in weekly sprints as you can see in figure 1. This planning can be better observed in the Gantt chart below in Figure 2.

Sprint Backlog	Task Name	Assignee	Progress
Sub-tasks			
Writing the report	Team 1	Planned	0%
Plan	Team 1	Planned	0%
Plan	Team 1	Planned	0%
User manual	Team 1	Planned	0%
Write	Team 1	Planned	0%
Constructing			
Assembling plastic plate	Team 1	Planned	0%
Assembling parts by plastic plate	Team 1	Planned	0%
Programming	Team 1	Planned	0%
Test electrical parts	Team 1	Planned	0%
Constructing electrical parts	Team 1	Planned	0%
Testing			
Prototype test	Team 1	Planned	0%
Improve the prototype	Team 1	Planned	0%
Preparing presentation	Team 1	Planned	0%

Figure 1. Sprint

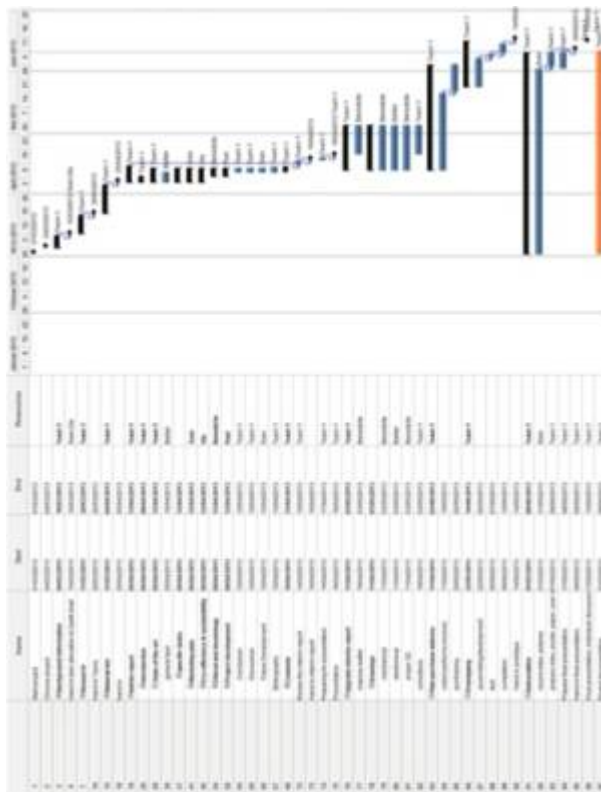

Figure 2. Gantt chart

Table 2. Task allocation

Tasks	Responsibility
Background information	Team 1
Hand in tasks	Ola, Sven
Research	Team 1
Hand in tasks	Paul
Marketing suggestion	Sven
Material list	Ola, Benedicte, Paul, Bartek
Introduction	Team 1
State of art	Ola, Benedicte, Paul, Bartek
Eco-Efficiency & sustainability	Ola
Ethical & deontology	Benedicte
Project development	Team 1
Preparing for presentation	Team 1
Purchasing	Team 1
Constructing of prototype	Team 1
Video	Sven
Paper	Paul
User manual	Ola
Poster	Benedicte
Programming	Bartek, Ola
Assembling report	Paul, Sven
Preparing final presentation	Team 1

1.7. Structure of the Report

This report is structured in seven different chapters.

The first chapter is the Introduction and presents the problems we are facing, the motivation, the objectives and the results we expect to achieve.

In the second chapter, the State of the art, we describe the different technologies already available in this fields, and present the ones that we have chosen to use in our project.

The marketing plan, included in chapter three, presents the Market analysis, positioning and segmentation as well as a Market mix.

In the fourth chapter we present the Eco efficiency Measures for Sustainability, highlighting the importance of sustainability in the engineering area and including a life-cycle, and energy consumption analysis.

The fifth chapter describes the Ethical and Deontological concerns of our project, it is divided into two subcategories: Legitimacy and Legality.

The sixth chapter of the report concerns the Project development where the proposed solution of our project is explained.

Lastly, in the conclusion chapter, the discussion about our project is included as well as reference to possible further developments.

2. State of the Art

In this chapter we will state what we are using for our solar algae dryer. Figure 3. gives a clear overview: how the solar algae dryer works.

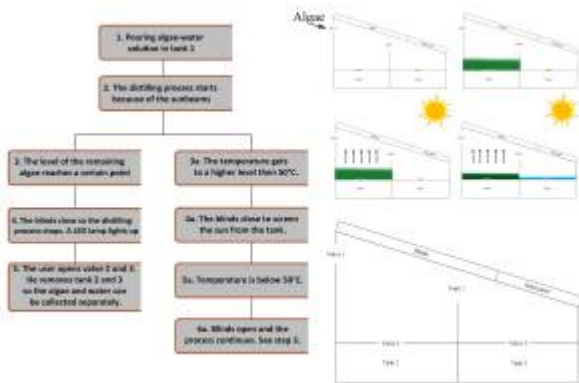

Figure 3. Overview

2.1. Requirements

From the very beginning our main concern was low power consumption. Studying the solutions present on the market and the one our client is utilizing - centrifuge, we noticed that in order to be competitive, we need to diminish the power consumption. Yet, there was some criteria we needed to follow - one of which was solar energy usage. We thought of many solutions including for example hydro cyclone or algae harvester working on assembly line, but as our aim was to minimize power consumption, we focused ourselves on distilling process.

We were supposed to work with solar power, taking advantage of that. Consequently, we decided to use direct solar radiation in distilling process to evaporate water. Also, the power coming from solar panel runs all the electrical appliances used in our product. Those are: microcontroller, diodes, temperature and level controllers and fan.

Not only the solar energy usage and low power consumption was our requirement, but also the budget of the project. Because of that, we tried to find all the needed parts at ISEP. While choosing the equipment necessary to build solar algae dryer, low, affordable cost, especially at local supplier's stores, was one of our major criterion.

It is also good to mention that our project is supposed to be replicated, hence our target is to create well working prototype suitable for tests concerning future enhancements.

Furthermore, the product must have had several functionalities. One of the major concerns was overheating of the solution. Algae may get damaged by excessive temperatures, so it was indispensable to secure the device with the temperature control system. We also wanted our system to inform us about the end of the whole process. All of the systems also needed to be controlled.

Furthermore, the product must have had several functionalities. One of the major concerns was overheating of the solution. Algae may get damaged by excessive temperatures, so it was indispensable to secure the device with the temperature control system. We also wanted our system to inform us about the end of the whole process. All of the systems also needed to be controlled.

2.2. Related Projects and Products

To find a proper process to dry the algae in a way that our products needs are fulfilled there must have been a research done on this topic. That is why we provided a search on methods and products that already exist and are used for algae cultivation. It is worth saying, that most of it are photo bioreactors, used for mass evaluation of algae species and their production. At this point it is worth to present how the photo bioreactor works. It is a closed system, that does not exchange gases and contaminants with the environment. It is referred as a bioreactor with a light-supplying system to introduce the photonic energy to the microalgae, in this case, to help it grow faster. Most of the times it is a system of pipes, with the solution of algae and water inside. There are few types of photo bioreactors, varying in position of the pipes. There are ones, that are built close to the ground, installed in parallel to the ground, just like the product in figure 3 from "Solix" which is a company from the United States [1].

Also another company from The Netherlands called Algaelink NV has a similar product. Its idea is also to dry algae with solar power. But the design is a thing that differs, it looks more like two ours combined together. The inclination starts from the top, in the middle and goes down both sides.

Another difference is of course the size. Its length is 18 m and drying area of 20 square meters, therefore much bigger. It is supposed to be used for mass-production. The water also evaporates only with the sun energy. But despite the fact that this product is very similar to ours, it has one important difference: it does not dry algae on a small laboratory purposes and is not controllable through electronic or mechanical devises.



Figure 4. Algae farm

This algae farm is built as a system of thin pipes to make sure that maximum amount of light comes to every single part of the solution to fasten the process. The advantage of this product is definitely high speed of growing of the algae and in a mass manner. However the disadvantage is that it is expensive to build. Therefore, as we need a device that dries just 5 litres of the solution, and that at the same time has to be cheap, this system does not fit our needs. As the algae farms using photo bioreactors are the most common way of harvesting the algae and of extracting the oil from them, it is worth saying a bit more about different types of the mentioned devices. Nowadays, one of the most developing types is so called "Christmas tree" photo bioreactor, designed by the German company "Gicon" in Dresden [2]. It is named that way, because it is wider at the bottom and gets narrower at the top, just as represented in the Figure 4 below:



Figure 5. Reactor [2]

This reactor is built in such manner to measure that the sunbeams get to every part of the structure as long as possible. Other advantage of this system is that it saves space in comparison to previously mentioned photo bioreactor of a traditional structure. Because of the pipes two-walled technology, it is possible to change the surrounding temperature extremely quickly, which also helps to harvest the algae rapidly. As the producer highlights, the design is extremely lightweight, therefore, easy to build and manage, and as they state, power-efficient, comparing to other existing technologies.

2.3. Tank

The main part of our project is the tank where the algae will be dried. Every part of the project has to fit with the tank, and therefore we need to have the tank as a base for our project. The whole system was supposed not to exceed 1 m², so we wanted the bottom of the tank to cover the most area possible. When deciding which material to use for the tank, we must start from the needs of the tank.

- It has to be completely waterproof
- At least the top of it has to be transparent
- It has to be easy to assemble
- Light material
- Environmental friendly material
- The price has to fit in our budget

With these needs we started to consider different materials to build the tank. In Table 3 we have listed the advantages and disadvantages for three different material solutions for the tank.

Table 3. Different materials for the tank

	Advantages	Disadvantages
Aluminium	5. Very good Thermal Conductivity (205) 6. Light material 7. Reflective 8. Durable material	3. Expensive 4. Hard to build with
Plexiglass	3. Transparent 4. Relatively cheap	2. Low Thermal conductivity (0.2)
Plastic	6. Cheap 7. Light 8. Durable 9. Easy to existing plastic parts 10. Easy to assemble	2. Low thermal conductivity (0.1-0.3)

After analysing this, we thought that it would be a good idea to build the tank out of aluminium, because of its good thermal conductivity. But after considering the alternatives a little bit more we stated that the plexi glass will probably be the best solution. We would anyway need the plexi glass for the top of the tank, and therefore it would be the best way to build the whole tank out of plexi glass. In this way we can assemble it more easily and we also get transparent sides for the tank. Plexi glass is also cheaper than aluminium and it's not too heavy. We can also easily make the bottom of the tank absorb the sun more efficiently by painting it black or reflect the sun by adding mirrors.

2.4. UV & Plexiglas

One of the very important aspects as far as algae drying is concerned, is to make sure they will not get damaged during drying. It is known that algae suffers from excessive UV radiation. As our device serves for drying algae with the help of sun beams, they will be constantly exposed to UV radiation. Hence, in order to prevent damage, it is wise to install some kind of filter protecting them from harmful UV radiation. Before coming to solution, let us firstly focus a little on UV radiation itself.

According to Gary Zeman member of the Health Physics Society, ultraviolet radiation is this part of the light invisible to our eyes, a portion of electromagnetic spectrum in between 400 - 100 nm. In addition, it also has its main components, which are UVA (320-400 nm), UVB (290-320) and UVC (220-290 nm) radiation. The most common one is the UVA radiation needed by humans for the synthesis of vitamin D, UVB radiation, on the other hand, is considered the most harmful. That is due to the fact that this kind of UV radiation has enough energy to cause "photochemical damage to cellular DNA" [3].

Obviously, such problem cannot be ignored especially if our aim is to get advantage from algae structure. Destructive properties of UVB are also proven by the fact that it impairs photosynthesis in many plant species, so also including microalgae [4].

We have considered two possible solutions. The first one is very simple - glass. Glass blocks over 90% of the light below 300 nm [5], so the hurtful UVB radiation will not affect the process. In order to get 100% protection, we thought of using laminated glass. It consists of two pieces of ordinary glass connected by PVB - Poly Vinyl Butyral. Such structure ensures 99% of UV radiation blockage, but it is also very hard, which gives us the other advantage in our design properties [6]. The other advantage is that glass is completely transparent, and taking into account fact that our distiller needs light to warm up the solution to get it evaporated, this feature is really important. Transparency means that it does let through the visible light and Infra red (IR), which causes heat. The device is aimed to be used outside, thus glass transparency seems extremely proper.

The other solution is plexi glass, so Poly(methyl methacrylate). It has almost the same properties as simple glass does, but has a main advantage over glass. Meaning, it is significantly lighter. This feature comes in really handy, taking into account the fact that we are considering the dryer prototype to be replicable. One cannot imagine a huge container made of glass that can be easily reassembled or to be lifted up. According to the producer, plexi glass has following properties: it has low density, so it lets the sun beams through easily, its resistance towards abrasion is close to the one of aluminium, it is resistant to any chemicals, it is completely transparent (this feature was already mentioned to be of great importance) and the most important is that it is a protection from UV radiation [5].

2.5. Temperature controller

One of the requirements of our solar dryer was to have a temperature controller installed. This is necessary to protect the algae, because the algae will get damaged if the temperature rises over 50° C. The requirements of this temperature controller are:

- measure the temperature inside the tank
- produce the sound when temperature rises to 50°C → Adjust the temperature
- be waterproof

For this purpose we were thinking of using a temperature sensor that will measure the temperature inside the tank and if/when the temperature rises to 50° C it will give a signal to the micro-controller and the cooling down process will start. The chosen temperature sensor is a waterproof temperature sensor model DS18B20. This temperature sensor is connected to our Arduino micro-controller and sets an alarm when the temperature rises above 50°C. The block diagram of Figure 5 shows the major components of the DS18B20. The DS18B20 has four main data components: - 64-bit lasered ROM, - temperature sensor, - non-volatile temperature alarm triggers TH and TL, and - a configuration register. [7].

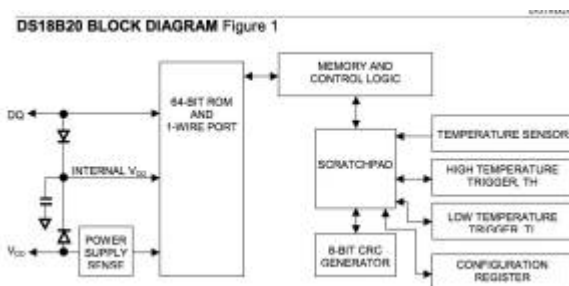

Figure 6. Block diagram for temperature sensor [7]

Features of temperature sensor DS18B20:

- Requires only one port pin for communication
- Requires no external components
- Multi drop capability simplifies distributed temperature sensing applications
- Power supply range is 3.0 V to 5.5 V
- Zero standby power required
- Measures temperatures from -55°C to +125°C
- +/- 0.5°C accuracy from -10°C to +85°C
- Thermometer resolution is programmable from 9 to 12 bits
- Converts 12-bit temperature to digital word in 720 ms (max.)

- User-definable, non-volatile temperature alarm settings
- Alarm search command identifies and addresses devices whose temperature is outside of programmed limits [7].

2.6. Water level controller

In order to be able to control when the drying process is ready, it is necessary to have some kind of sensor that tells us when it is ready. The best way of doing this is to put a sensor attached to the water level that alarms when we have reached our goal of 10% water left in the solution. The requirements for this sensor are:

- be precise (water level will drop from ~20 mm to ~2 mm)
- be able to work in temperatures between 0°C - (+)60°C
- give a signal to the micro-controller when the water level is low enough (drying process ready)

When facing this problem we thought about different solutions to solve it, they are listed below in table 4, considering their advantages and disadvantages.

Table 4. Water level sensors

Type of controller	Advantages	Disadvantages
Liquid level sensor	-Cheap -easy to install	-hard to find precise enough
Optical sensor	-precise	-Expensive -problem to install inside
Ultra sound level sensor	-Precise -Fits for our product because it can measure short distance -Cheap because we have one already and don't need to buy it	

The easiest and cheapest way to control the water level is the liquid level sensor. It works with a moveable float, and floats with the water level, and it can be adjusted to the water level you want it to alarm. The problem is that it's hard to find one able to measure the levels that we are going to have in our tank. Because of this problem we will choose the Ultra sound sensor. There is already one at school that can be used, and it will be adaptable to our solution. This sensor will be connected to the Arduino micro-controller, and alarm when the water level is low enough and the process is ready. Ultrasonic level sensors are used for non-contact level sensing of highly viscous liquids as well as bulk solids. They are also widely used in water treatment applications for pump control and open channel flow measurement. The sensors emit high frequency acoustic waves that are reflected back to and detected by the emitting transducer. The chosen sensor is a Devantech SRF04 Ultrasonic Range Finder.

Below features of the ultra sound sensor are presented and also a picture of the SRF04 in Figure 6.

Features:

- Voltage – 5 V
- Current – 30 mA
- Frequency – 40 kHz
- Max range – 3 m
- Min range – 3 cm

- Sensitivity - Detect 3 cm diameter broom handle at > 2 m
- Input Trigger - 10 uS min. TTL level pulse
- Echo pulse - Positive TTL level signal, width proportional to range.
- Small size - 43 mm x 20 mm x 17 mm height [8].



Figure 7. SRF04 Ultrasonic Range Finder [8]

2.7. Fan

The speed of the distilling process depends on the speed of evaporation. Evaporation speed depends on the temperature of the air and the algae, size of the exposed surface to the air, concentration of the substance evaporating, pressure and the flow rate of air. We can control this last factor. We want to make the air circulate by adding a fan. We considered a fan with a heater build in. But we decided that the gain of hot air is not worth the loss, it uses a lot more energy.

Then we had an option to make the system closed or open. If the system would be open, there would be a supply of colder fresh air. But since we don't need the supply and the inside air just needs to move faster we decided to make the system closed. Another advantage of a closed system is the fact that it is more weather proof, for instance no rain can enter the tank. Our choice was to use Humid protect 12 V DC fan. The model that we decided to buy has following specifications:

Table 5. Fan specifications [9].

Frame Dimensions:	92 x 92 x 32 mm
Supply Voltage:	12 V
Flow Rate:	1.32 m ³ /min
Bearing Type:	Ball
Power Connection Type:	Wire Leaded
Series:	3300
SVHC:	No SVHC (19-Dec-2012)
Current Type:	DC
Operating Temperature Max:	75°C
Operating Temperature Min:	-20°C
Power Consumption:	2.5 W
Type:	Humidity Protected

Taking into account the power consumption and the expected power output of solar panel, we believe it can properly work for the time of evaporation.

2.8. Microcontroller

To make sure, that the whole system works just the way we want it to, we have to install a

microcontroller, which has to be programmed to distribute tasks to the previously mentioned parts, such as temperature controller, level controller, the diodes, fans and a mechanical system responsible for reducing the temperature inside the tank, not to be higher than 50°C. The board we chose is Arduino Uno board with microcontroller ATmega328.

We use it, because of its simplicity, but at the same time enough number of analog and digital ports. Because of the fact that we require just one analog and few digital ports such board is enough. Here in Table 1. are shown the official specifications taken from the producer's webpage.

Table 6. Arduino specifications [10]

Microcontroller	ATmega328
Operating Voltage	5 V
Input Voltage (recommended)	7-12 V
Input Voltage (limits)	6-20 V
Digital I/O Pins	14 (of which 6 provide PWM output)
Analog Input Pins	6
DC Current per I/O Pin	40 mA
DC Current for 3.3V Pin	50 mA
Flash Memory	32 kB (ATmega328) of which 0.5 kB used by bootloader
SRAM	2 kB (ATmega328)
EEPROM	1 kB (ATmega328)
Clock Speed	16 MHz

Below in Figure 8. the Arduino Uno board is shown:



Figure 8. Arduino Uno [10]

2.9. Solar Panel

The main idea of this project was to power up the system just from the solar panel. It had to be checked what output power would satisfy our needs and it has been decided that 15 W solar panel would be required. Below are shown initial calculations to make sure that the power output from the panel is enough to support all components of the system. Concerning the peak power of the solar panel it will reach the value of 360 Wh a day at its maximum. Using the PVGIS site we may calculate the average power taken from the sun in different areas of the world [11]. Another aspect, that is needed, is the factor that describes ratio of power output per hour and peak power of the solar panel at concrete place on Earth. In our case it is North of Portugal and the value is equal to 1400 kWh/kWp.

Per one day, one fan consumes:

$$2.5 \text{ W} \times 24 \text{ h} = 60 \text{ Wh}$$

Arduino needs 12 Wh and the diodes need around 10 Wh. Summing up maximum power consumption a day equals 82 Wh. So in a year we would need:

$$0.082 \text{ kWh} \times 365 \text{ days} = 29.93 \text{ kWh per one year}$$

Taking into account the factor discussed previously, in this region peak power needed to support our system is equal to:

$$29.93 \text{ [kWh]} / 1400 \text{ [kWh/kWp]} = 21.4 \text{ Wp [watts peak]}$$

As can be easily seen this value exceeds the peak power of our chosen solar panel, but it is worth to point out, that these calculations refer to weather conditions throughout the whole year, also on the cloudy days. At that time our product would not be effective and probably also not used. Due to the fact that our goal is to provide a product that is, at the same time, not bigger than one square meter, power saving and cheap, we would not like to use a bigger panel. It would of course develop the operation of the device, but would highly rise the costs.

For the ultrasound sensor and temperature sensor there are no official data in the datasheets, concerning power consumption of these devices, but it is stated that they are can be supported with the power from the data line, so we may assume that the amount of output power of our solar panel more than enough for these two controllers. Other components that gain power from the supply are two diodes, but as in previous case the amount of power needed for their operation is not very significant. The power of a diode is easy to be calculated from the formula:

$$P = V \times I, \text{ where}$$

V - voltage on the diode I - current flowing through the diode

Knowing, that the voltage on the diode generally does not exceed 3 V and the current values of standard led diodes do not exceed 75 mA the maximum power on the diode is 0.225 W, so 0.5 W is enough to support both of them.

Other components of the system that have to be powered by the energy taken from the sun, as previously mentioned, are the temperature controller, level controller, diodes indicating if the wanted level of the liquid has been reached or if the temperature exceeds 50°C. Other part of our design that has to be supported by the power from the solar panel is the step motor, working with blinds on the top of the tank to control the temperature inside the dryer, by reducing the sunbeams acting on the algae solution. Of course the whole system could not work with the energy taken directly from the panel. It happens due to the fact, that the sun does not operate on the same level of intensity all the time and the idea for the system is to work all the time. That is why the battery was needed to be applied to be charged by the panel. We have chosen a 12V/ 2.3 Ah battery, because the whole circuit is supposed to operate in this voltage. Therefore, an additional circuit between the panel and the battery will be needed to make sure that the battery lasts for longer time.

The panel that we chose is shown in Figure 9 below:



Figure 9. Solar panel [9]

Table 7. Solar panel specifications [12]

Power Rating	15 W
Power Voltage Max	17 V
Current at P Max	890 mA
Open Circuit Voltage	21.5 V
Short Circuit Current	970 mA
Length	507 mm
Width	296 mm
Height	25 mm
Weight min.	2.56 kg

2.10. Battery

In order to supply our device with electricity all the time we need a battery. There are many different types of batteries and here are presented the most common ones.

Nickel Cadmium (NiCd) — mature and well understood but relatively low in energy density. The NiCd is used where long life, high discharge rate and economical price are important. Main applications are two-way radios, biomedical equipment, professional video cameras and power tools. The NiCd contains toxic metals and is environmentally unfriendly.

Nickel-Metal Hydride (NiMH) — has a higher energy density compared to the NiCd at the expense of reduced cycle life. NiMH contains no toxic metals. Applications include mobile phones and laptop computers.

Lead Acid — most economical for larger power applications where weight is of little concern. The lead acid battery is the preferred choice for hospital equipment, wheelchairs, emergency lighting and UPS systems.

Lithium Ion (Li-ion) — fastest growing battery system. Li-ion is used where high-energy density and lightweight is of prime importance. The technology is fragile and a protection circuit is required to assure safety. Applications include notebook computers and cellular phones.

Lithium Ion Polymer (Li-ion polymer) — offers the attributes of the Li-ion in ultra-slim geometry and simplified packaging. Main applications are mobile phones. Table 8 compares the characteristics of the six most commonly used rechargeable battery systems in terms of energy density, cycle life, exercise requirements and cost [13].

Table 8. Different battery types [13]

	NiCd	NiMH	Lead Acid	Li-ion	Li-ion polymer	Reusable Alkaline
Gravimetric Energy Density (Wh/kg)	45-80	60-120	30-50	110-160	100-130	80 (initial)
Internal Resistance (includes peripheral circuits) in mΩ	100 to 200 ¹ 6V pack	200 to 300 ¹ 6V pack	<100 ¹ 12V pack	150 to 250 ¹ 7.2V pack	200 to 300 ¹ 7.2V pack	200 to 2000 ¹ 6V pack
Cycle Life (to 80% of initial capacity)	1500 ²	300 to 500 ^{2,3}	200 to 300 ²	500 to 1000 ³	300 to 500	50 ³ (to 50%)
Fast Charge Time	1h typical	2-4h	8-16h	2-4h	2-4h	2-3h
Overcharge Tolerance	moderate	low	high	very low	low	moderate
Self-discharge / Month (room temperature)	20% ⁴	30% ⁴	5%	10% ⁵	~10% ⁵	0.3%
Cell Voltage (nominal)	1.25V ⁶	1.25V ⁶	2V	3.6V	3.6V	1.5V
Load Current						
- peak	20C	5C	5C ⁷	>2C	>2C	0.5C
- best result	1C	0.5C or lower	0.2C	1C or lower	1C or lower	0.2C or lower
Operating Temperature (discharge only)	-40 to 60°C	-20 to 60°C	-20 to 60°C	-20 to 60°C	0 to 60°C	0 to 65°C
Maintenance Requirement	30 to 60 days	60 to 90 days	3 to 6 months ⁹	not req.	not req.	not req.
Typical Battery Cost (US\$, reference only)	\$50 (7.2V)	\$60 (7.2V)	\$25 (6V)	\$100 (7.2V)	\$100 (7.2V)	\$5 (9V)
Cost per Cycle (US\$) ¹¹	\$0.04	\$0.12	\$0.10	\$0.14	\$0.29	\$0.10-0.50
Commercial use since	1950	1990	1970	1991	1999	1992

At first we thought about placing 12 V battery, but because of the lack of the fan in our system we chose a 9 V battery. We did it due to the fact that every other part works on 5 V. The battery we chose is shown on the Figure 9 below.

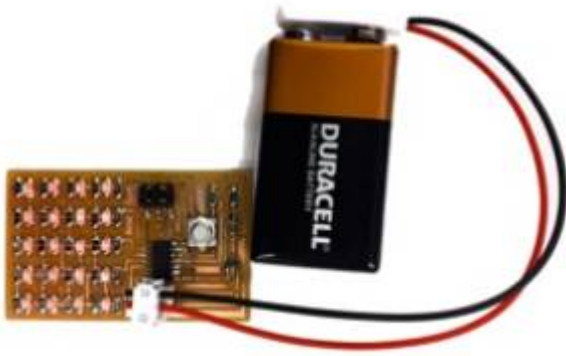

Figure 10. 9 V type battery used

2.11. Stepper motor

In order to control the temperature inside the tank we need to be able to cover the top of the tank, for this we are using blinds and for controlling the blinds we need a motor. The stepper motor will be controlled by the Arduino and regulate the blinds according to the temperature inside. The requirements of the stepper motor is to be powerful enough to control the blinds but at the same time not use a lot of power. The step motor we have chosen is a 12 V Astrosyn Y129 stepper motor shown in figure 10.



Figure 11. Stepper motor

2.12. Conclusions

Summing up, all the products that we have chosen after a brief research were picked because of their contribution to our product, being low energy consuming, cheap and that it would fulfill our needs. We chose such solar panel due to the fact that it just has to be powerful enough to supply power to other components and cannot be too heavy. The fan have to give enough velocity of air to rise the speed of the process.

After a huge study of temperature and liquid level controllers we decided to use ultrasonic level controller. The reason was that most of other products did not have such small range of operation, as we needed. The temperature controller however was chosen because of the fact that it sends analog signal, what facilitates circuit design. The last component to select was the microcontroller, which had

to be simple, because of the fact that our circuit is not a complicated one. The only thing that had to be checked was the number of digital and analog ports in the board. That is why Arduino Uno was chosen.

3. Marketing

3.1. Introduction

Executive summary

In times of worldwide air pollution and decreasing energy resources it is absolutely necessary to support systems that do not harm product environment and use less energy. Our product will fit into the actual eco-political and economical trends of "green energy". To concentrate on the right competitive advantages of our product, it is very important to study potential competitors and of course the customer needs. Therefore we will concentrate on the European market for analyzing the advantages and disadvantages of nowadays' solutions.

Product description

Product: Solar dryer

Definition:

- What?

Our project is to develop a microalgae dryer, powered only by solar energy. We dry the algae by evaporating the water.

* Wherefore?

At the moment one of the biggest challenges is the enormous consumption of fossil fuel. In contrast to ordinary systems the oil contained in micro algae can be used as an ecological and sustainable solution because it is usable as alternative fuel.

- Why?

We want to be part of the development of a more ecologically friendly solution for fuel. We believe that we have developed a solution which is in line with the current eco-political and economical trend of "green energy". Today's fuel is limited and polluting the Earth.

- How?

The Solar dryer is going is a solution that is very energy-efficient and uses renewable energy. As a by-product the algae absorb CO₂ to produce biomass.

3.2. Market Analysis

A comprehensive market analysis examines the attractiveness of a special market within a specific industry. This can help to determine the target market and the need for the product. In order to be

successful with the launch of a product, in particular the “Solar Dryer”, a scan of the internal and external environment is an important part of the strategic planning. In order to identify and document strengths, weaknesses, opportunities and threats we will use the SWOT Analysis. The external environment includes all factors with impact from the outside. They are influencing the ability to develop successful relationships with the target customers. With regard to the specific company, these factors can be divided into micro environmental and macro environmental.

3.2.1. Macro environment

In general, the macro environment is composed of those factors on which the company has very little impact on and they often require changes in several marketing aspects. The important factors comprising the macro environment of marketing are demographic, economic, socio-cultural, natural, technological and political-legal. We describe the influence of each factor in more detail in the next sections. Regarding our project, the macro environment is concerned demographic, technological and political aspects. These are characterized in the next sections.

3.2.1.1. Demographic

Demography is the study of human population, which includes different types: density, location, age, occupation and other terms. The major interests of marketers are people, because demography involves people and people create markets. The only constant thing in life is changing, the same applies for demographic trends.

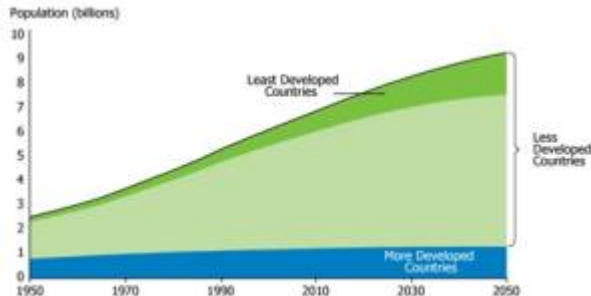

Figure 12. Demographic chart

The demographics development shows that the population has increased.

Figure 12 above shows that the worldwide population will increase to about 8 billion people in 2030. Worldwide, there are around 900 million cars in 2007, of which 231 million in the EU [14]. This number increases to 1.069.097.774 cars in 2011 [15]. Consequently, we have about 200.000.000 new registered cars from 2007 to 2011. One reason for this is, that mobility and flexibility are becoming important topics to be successful and competitive in times of growing globalization.

Table 9. Cars per inhabitants (APA/Red.)

Overview	
USA:	775 cars per 1000 Inhabitants
Luxembourg:	655
Italy:	605
Germany:	573
Austria:	511
EU:	467

A serious resulting problem caused by the increasing population is high air pollution. Nevertheless, the energy reserves decrease rapidly and as a consequence the need of alternative fuel increases. This shows all the more that our system should run with renewable and sustainable energy.

3.2.1.2. Political

Political factors influence organizations in many ways and are able to create strengths and opportunities for organizations.

Finally, since the failure of the UN Climate Change Conference in Copenhagen 2009, everyone should be aware of its results. It was one of the biggest conferences in history, but unfortunately the one with the most unsatisfactory results [16]. A solution to be followed after the Kyoto-Protokoll was not found as well as none affirmative covenant concerning the bisection of carbon dioxide emissions was made. Anyway, most of the European states already implemented some concepts in order to work on these challenges.

For instance, the German government supports research programs in the “green energy” area [17]. The university of Senftenberg and the “Green Mission” GmbH got 4 million Euros for the algae research in 2010. Concerning research, the three main categories are taken into consideration: Which strain of microalgae is the best? What is the energy balance of the algae cultivation? At what amount of CO2 supply do algae grow most effectively?

Meaning, rather they are not interested in drying the algae as fast as possible. The aim of this project is to get satisfactory results to answer the three main categories. Consequently, these should be our target projects, because we find a current win-win situation. This implies that we are able to integrate

our solution in the existing system enabling them to get the necessary power by solar energy instead of fossil energy sources, and we will get the needed information to modify our system.

Other opportunities to raise the financial resources are funds from the European union. For instance, the Eco-innovation initiative is a part of the EU's Competitiveness and Innovation Framework Program (CIP) [18]. This program is also linked to the Eco-innovation Action Plan (EcoAP), Europe's green technology roadmap and the policy background for Eco-innovation [19]. These initiatives enable new products, processes or services which will create a beneficial impact on the environment to get into the market. Basically, this fund will not finance the whole requirements of our product. Nevertheless, it is useful to improve our product. Finally, we believe that we could be able to produce at lower cost as well as decrease the cost of the market launch.

3.2.1.3. Technology

Technology means continuous change. Consequently, technological force is rising by the used level of development and influencing organizational degree. Currently, we are using the newest technology and the fact that the whole system runs on solar energy also meets future trends.

3.2.2. Microenvironment

The microenvironment consists of five components. The first component is the organization's internal perspective and its effects on the different departments. It is known that its several departments management levels have a great impact on the decision making progress. Secondly, microenvironment deals with suppliers, the intermediaries and the new developers cooperating with the organization. The third component considers the potential market, the producer, consumer, reseller, government and international markets. The prospective customers belong to the fourth part. The fifth component of the microenvironment consists of the public, including all potential organizations, which have an actual interest in the organization's accomplishment to achieve its objectives.

3.2.2.1. Internal perspective

Referring to the organization's internal environment as described above our organization is a team of four students from different faculties. Analysing each other's capabilities we appointed each person to act as a manager of a certain department. Due to the fact that each member has its own responsibility we are able to make decisions in terms of the product's development and product launch.

3.2.2.2. Intermediaries

In this case Intermediaries are not relevant for our solution. The product we are going to develop is really specific and requires explanation. Therefore, it is really important to focus on "one to one" marketing. If we are thinking about the future, could be interesting working with intermediaries since the market is aware of our product.

3.2.2.3. Customers

After analysing the market in terms of prospective customers, we identified companies in the energy already using the microalgae production to produce fuels. Accordingly, these companies are familiar with the idea and have already developed systems gaining biodiesel out of microalgae. We recognized that almost each company uses their own technology to dry the algae. In order to meet those needs, our product is developed on a standardized solution but it also offers features that can be customized to apply individual needs. Thereby the prospects have the opportunity to choose the most suitable solution. In Appendix we have included a list of international prospects.

Table 10. Different algae related companies

Company	Country	Task field
Solix Biofuels	USA	Energy production from algae
Biofields	Mexico	Biodiesel from algae
BioCentric Energy	USA	Biodiesel from algae
Solazyme	USA	Biodiesel and food products from algae
Seambiotic	Israel	Production of microalgae with CO ₂
TransAlgae	Israel	Energy and food products from algae
Cavitation Technologies	USA	Oil production from algae
Symple Green Biofuels	USA	Biofuels from algae
Algenol	USA	Biofuels from algae
Algaetech International Sdn Bhd.	Malaysia	Algae related Industry
Sapphire Energy	USA	Green Crude production
Synthetic Genomics	USA	Developing biological solutions
Ingepro B.V.	Netherlands	Production of algae
Greon	Bulgaria	Biotechnology and ecotechnology
Alvigor AG	Germany	Production of algae

The table shows that most of the potential customers are placed in the USA, but our current solution is not yet adjusted to their needs. Because these companies are focused on mass production and requiring a solution that fulfill their expectation of capacity, efficiency and establishment. In order to meet those needs we are going to improve our product making it the most suitable as possible for a sustainable relationship towards future prospects. Referring to the European market we also found some prospects, these are shown in Table 11 below. We are going to enter this market first, because with the use of given opportunities, which will be defined in the following, we are able to minimize existing market barriers. An other result of our market analysis is that universities and institutions belong to our potential customers, as they have been involved with the algae production, too. We believe that we can integrate our solution in existing systems enabling them to get the necessary power by solar energy instead of fossil energy sources.

Table 11. European prospects

Institute	Country	Task field
Microalgae Biotechnology Group (CSIC's)	Spain	Producing oil from algae
University of Sheffield	United Kingdom	Producing oil from algae
University of Glasgow	United Kingdom	Algae production for oil and energy
University of Cambridge	United Kingdom	Algae production
European Algae Biomass Association	Italy	Network of industry and research
Ruhr-Universität Bochum	Germany	Formation of hydrogen using green algae for fuel cells
Fraunhofer Institut for Biotechnology	Germany	Algae production in bioreactor for material and energy
TU Berlin	Germany	Algae in the water restoration
Projekt HydroMicPro	Germany	Hydrogen from algae (fuel cells)
Brandenburgisch Technische Universität Cottbus	Germany	Department of Conservation

Due the fact that our potential customers are organizations and institutions we distribute our product via Business-to-Business (B to B). Although our prospects are already operating in this very special market the "Solar Dryer" is still a specific product that requires explanation. As a result of this, we decided to focus on "1:1 Marketing" activities. Referring to our organization this involves the person responsible for sales listening carefully to what the customer requires and then proposing how the product can be customized in order to replace the current power unit.

3.2.2.4. Competitors

As long as an organization has no monopoly position it faces competitors affecting ones business's profits by trying to take business away. Meaning, basically each prospective company can be a customer or a competitor. Referring to our target market the aim of the relevant companies is the mass production of algae. However, we identified a few companies listed below. These companies primarily specialized in producing and selling components to dry the algae.

Table 12. International competitors.

Company	Country	Task field
Subitec	Germany	Production of algae biomass
Blue Biotech	Germany	Production, trade, sales of algae
Algomed	Germany	Products from algae
Breen Biotec	Germany	Biodiesel from algae
Alpha Biotech	France	Research & Development
AlgaFuel S.A.	Portugal	Research & Development
AlgaeLink N.V	Netherlands	Algae producing systems
Alvigor	Switzerland	Technology for production
LGem B.V.	Netherlands	Technology for production
OriginOil	USA	Technology for extraction
Parabel	USA	Unique micro-crop technology

The general problem of nowadays' solutions is the waste of energy. Furthermore, these systems have to decrease the high consumption of used materials and change to alternative energy instead of fossil fuel or electricity to run their system. Nevertheless, most of the existing solutions are faster then our system is going to be. Therefore, it is our aim to identify these strengths and weaknesses and using

the obtained know how to create a sustainable and competitive solar dryer.

Currently, most of the existing parts are ideal for prototyping and adjust our client needs. But through permanent dialogs with prospects and carefully listening to their requirements we are able to specify our product towards future needs. As a result of this it is our objective to develop a strong competitive advantage by running the whole system on solar energy, decrease the energy consumption ,and finally create a solution which is easy to establish. Hence, our product delivers more added values for our customers than that of our competitors.

3.2.2.5. Suppliers

Furthermore, we intensify the networking with suppliers. We believe that cooperating with the energy sector is the first step to enter the market. Trough this network we can reach a large target market and our target costumers. For instance the networking with Achilles could be interesting. Communities for buyer or supplier already exist in the Achilles Group [21]. In addition to that we can use an existing system, and must overcome the need for complicated market immersion barriers. This allows us to quickly draw attention to our product without investing great marketing promotion.

3.3. SWOT - analysis

To summarize the objectives concerning our product a SWOT analysis was made. The following table shows the clarified ideas (advantages & disadvantages of the environmental analysis).

Table 13. Swot analysis

Strengths	Weaknesses
use "green" energy (solar)	system uses a lot of time for evaporation
adaption module	materials are ideal/suitable for prototyping
participate in sales network	limited financial resources
our system uses less energy	seasonal operation mode (summer, sunny days)
the whole system runs on solar energy	lack of time to improve the system
less consumption in general	
possibility to install water recovery system	
all the parts may be either recycled or reused	
Opportunities	Threats
existing funds	product acceptance
supporting initiatives	prototype may not meet our assumptions
playing major role in harvesting algae research	longer evaporation period, blinds and mirrors may not work
	lack of possibility to build replicated product with the same materials

3.4. Strategic objectives for our project (3-5 years)

In order to achieving an applied vision of our product and generate greater profit it is necessary to develop long-term, continuous strategies. Referring our product the following strategic objectives were defined.

1. Development of adaption module within 3 years
2. Customer satisfaction and long-term relationships
3. Spread our product to Europe within 5 years
4. Differentiation of module and service

3.5. Market segmentation

Market segmentation is the process of identifying prospective segments within the general market. Market distribution is really important because with the knowledge of our target market we are able to meet customer's needs and create competitive advantages.

Summarizing the previous market analysis and objectives listed in the SWOT, is the result that the energy market is the most interesting market for our product. Because currently we have a lack of financial background and R&D resources, consequently choosing the market with the lowest barriers is one of our approaches. Referring to the market analysis the European market consists of the needed circumstances.

Even though, the main aspects of the analysis shows that most of current used materials are ideal for prototyping, but do not fulfill prospect's needs because the product is adjusted to our client needs and these are not future needs. In the current situation it is challenging to enter the chosen energy market. Nevertheless, the bio diesel extraction out of algae is a new technology. Consequently, the research and development in this area is at its beginning. This implies that the demand of new eco-friendly solution exists.

Referring to our product it shows that we have to equip the solar dryer with specific functions. This enhancement leads us to change our first approach, which was to concentrate first of all on the European market first, into modifying it first of all.

To understand and meet customer needs, we need to know the main challenge of our target market. Today the major question many companies in the energy sector trying to answer is the following: How can we produce enough algae in order to meet the demand for alternative fuel such as for biodiesel? Concerning our product the market analysis shows that there are several well-established companies (e.g. Algae Link N.V. [22]) with a large financial background and specialized faculties enabling them to focus on mass production and distribution. Currently, the solar dryer cannot fulfill these given requirements so our product has to be further developed in order to replace conventional methods. However, our product is applied to meet the requirements in the future because most of the existing solutions are inflexible and have high energy consumption. Our value proposition is to develop a solar dryer which consists of the following features; large function variety, easy to establish, meet the customer's sustainable approach, runs only on solar energy, and has less energy consumption. Only if we continuously enhance and adjust our product we believe that we are able to meet the long-term requirements of the energy market.

Therefore we split our target market into two groups. First we are selling our product to prospective universities to modify and improve our prototype. We are especially looking for independent laboratories researching to find the most efficient microalgae. The attractiveness referring this collaboration is based on collective conception of a sustainable future. Our solar dryer supports this behaviour and through this collaboration and the given results we are able to modify it successfully. After modifying our system and improving it towards future needs, our product will be able to enter

the European Energy Market.

Available structures for implementation are placed in Europe. As already mentioned in the previous part, different opportunities such as existing funding's supporting our product are given. Furthermore, political trade barriers are minimized, and the fact that all team members have gained their knowledge in different regions of Europe could be helpful to enter the market. In terms of launching our product in Europe we also take advantage of the fact that each team member comes from a different country in Europe.

Once our product is well established in Europe we believe that the American market offers further opportunities. This market also consists many competitors but with comparable inflexible solutions entering the market with an improved solar dryer will be possible. Referring this the remote future is to spread our product to Europe and gaining as much market share as possible. Afterwards, with the usage of advanced know how, gained experiences, and a solar dryer with outstanding features will enable us to access the American market.

3.6. Market positioning

The positioning task considers three steps: At first identifying possible competitive advantages, then choosing the right advantage, building up a basic position and selecting a collective strategy. It is very important to communicate the chosen position effectively to the market. The market segmentation and SWOT-analysis shows that the development of our product has to be orientated towards our customers' approach because the circumstances in the existing market are different as well as duration and functionality. It appears that the existing solutions are inflexible and do not offer many features. To be successful once our potential target audience is convinced that our system does not only fulfill their requirements but also supports our customer's own sustainability approach. Based on these results an effective positioning is realizable in the energy market. Certainly, improving and modifying our prototype is really important to develop a conclusive solution that is competitive.

The collaboration with universities is a vital step as this will give us the required know how, experiences in daily work, requirements of features and the demand of capacity. As a result of this, it is our objective to develop a strong competitive advantage by decreasing the energy consumption, run the whole system on solar energy and add several features for specific customer needs.

Referring our product and concerning our value proposition it has to be differentiated in several tasks. We believe that our product cannot be a "stand alone" solution. Once our system is installed our customers will not only be supported by our Customer Care Team but also be informed about the future development by our After Sales Service. This service plays an important role in terms of our product's USP (unique selling point). Additionally, we will have an on-going development to gain as much market share as possible.

Summarizing our strategy. In total we will offer a main solution with an adaptation module that is easy to establish and adjusted to energy sector requirements listed above. In the first two to three years we pay attention on developing our competitive advantages through carefully listening to future requirements. In the following years we try to integrate our product in the European energy market by differentiating it in several tasks. In the distant future, since the market is already aware of our product and we are able producing it massively, we are going to participate in the American market. Through a mass productive solar dryer and the gained know how the American market requirements can be fulfilled.

3.7. Market Mix

3.7.1. Product

Our organization will offer a solar dryer that is a system consisting of a main solution with an adaption module. The adaption module is designed for specific customers' needs such as capacity for bigger tanks. With this product customers can choose the most suitable solution regarding their specific demand.

Even though the solar dryer is designed to dry algae in order to gain bio diesel out of the algae it can also be used for the whole energy production with the usage of microalgae as base. As a result of this we are able to reach a larger target market.

Another way of differentiating our product is the service we offer. It will include the installation of the system, dedicated customer care and after sale service. This service packet supports the approach creating long-term engagements.

3.7.2. Price

Price policy consists of the following tasks: corporate objectives, analysis of price situation, price level strategy, operative price strategy and price adjustment. Researching consumers' behaviour and differentiating each aspect is important as it indicates how they will react on price fluctuation. We cannot define a price for our product yet, but we will set a price for the future product, because referring the price it is necessary to think about the adjusted product and not about the prototype designed for ISEP. To set a price in general every material and service have to be defined. For instance, we have to consider acquisition costs as well as profit margin. The price strategy plays an important role for a long-term successful development. Analyzing our product the price has to consider the following Material, building, distribution of the product, laboratory, cost of labor firstly.

All these components are not cost-intensive, so that a skimming strategy is not recommendable. Furthermore, we are not new in the market but with a quality product, which will fulfill specific needs. Anyway, the premium strategy is not countable for our product. There are more parts referring to the price clarified in the following.

Once our product is spread to Europe our approach is being in the lead of service. This service package will be sold as bundle to lower the cost for our customer. Additionally, through consisting opportunities, which are already mentioned in the section above, we will be able to produce the dryer at lower cost.

In terms of being a start up organization it is necessary to be profitable and gain as much market share as soon as possible. Achieving these goals, we are going to use the penetration strategy. Therefore we have to save costs and set a lower price in comparison to our competitors. In general, saving costs is realizable through an efficient purchase and with an increasing number of sales. In our case different options have to be considered because a certain number of reasonable sales figures cannot be forecasted.

Another opportunity is getting an agreement with a bank with the objective of a credit designed for start-up organization. We need to have low interest rate, as well as a long period of validity. Only then it would make sense to have an agreement in order to defray some of our costs. To arrange such an

agreement a detailed business plan demonstrating that we have a product with good opportunities in the target market will be the a prerequisite.

Comprising our pricing strategy the price is defined in two ways. On one hand lowering the costs in order to quickly earn market share. On the other hand, the price includes the complete service package and every defined task which is listed above. Finally, we are going to use an appropriate penetration strategy.

3.7.3. Promotion

Even though that intensive and penetrating communication is cost-intensive it is very important to provide information to the customer purchasing our product. The costs associated with promotion constitute the various types of advertising the product. Promotion is communicating with the client and fulfilling their wishes. Finally, successful promotion influence sales numbers and thereby it also has an impact on the allocated costs.

The budget determines the usage of different opportunities in promotion. To gain our organizational approach we have to use direct as well as indirect promotion clarified in the following.

Direct promotion is usable to carefully listen to prospects' needs and arouse attention to our product. In terms of our communication strategy, it will include several defined tasks starting with a trade show. The face-to-face contact with our prospects and customers is very important and is the prerequisite to establish a long-term relationship. Referring to our given budget a trade show is too expensive so we decided to share a stand with other universities or companies. On this stand we will provide our literature. Which is the right trade show? This is a really important decision in order to launch our product successfully. We always have to make sure that our prospects as well as the competition are aware of our product.

Examples for possible trade shows to take place are the following:

1. Algae Biomass Summit [23]
2. Algae Europe [24]
3. International Algae Congress [25]

Another opportunity in terms of direct promotion is to participate on events or larger presentation at universities dealing with the usage of the solar dryer. The face-to-face contact with our target market can be intensified and the interest in our product can be increased. Below the direct communication also indirect concepts should be established in our promotion. Referring to our organization we already have the knowledge that allows us to design a collaterals or a website. One team member studies industrial design and has the needed know how to concentrate on these topics. Concerning the budget it means that we can save costs and are able to spend money on other communication tools. For instance case studies in different economic publications are of interest. The budget does not allow us to place an advert but an option can be a short article in a dedicated magazine being read by our target market.

Finally, summarizing all tasks a slogan for our future development can be: "think global, act local".

3.7.4. Place

An organization has to pay attention to distributing the product to the user at the right place at the right time. It is important to have an efficient and effective distribution in order to meet its overall perspective. In this case, two types of distribution methods are obtainable: indirect distribution through an intermediary or direct distribution without any middleman.

A variety of figures have to add value during the choice of the right distribution method. For instance it is easier to sell simple and standardized products by the usage of intermediaries than complex ones. Another factor you have to take in consideration is the financial background of an organization. A lot of finance is needed in order to distribute the product to Europe or even worldwide. These circumstances are different and finally, it depends on the product being distributed. Concerning our product three steps being taken in consideration.

In the first phase our product is going to be sold to universities. In the first two years we are focusing on Business-to-Business marketing. This allows us to have a better influence on different topics such as price, product presentation and service to satisfy our customer and get a closer customer loyalty.

To achieve the first contact we want to participate in larger presentation days and be present on several new technology meetings. It is our objective to hold our own presentation in order to present our prototype to a broader audience. The face-to-face contact allows us to answer to specific questions and to strengthen our network. As we want to establish a sustainable collaboration, our organization as well as our partner has to identify themselves with our product.

Phase two deals with the entrance in the European energy market. In this phase it is necessary to sell our product via Business-to-Business. The solar dryer is at this point still a specialized product and consequently it needs a lot of explanation. Through a direct connection to our final customer we are able to control the whole distribution and work on upcoming questions directly.

Through existing networks, which we have strengthened in phase one we can minimize costs and quickly pay attention to a larger target market. In general B-to-B marketing requires a lot of time and commitment to our product. In our case, we want to create long-term relationships. Therefore, we are going to sell our product without involving intermediaries via direct distribution. In parallel an on-going development in existing cooperation is placed in order to keep our product at the newest level.

Phase three refers to the remote future. Once our product is successfully launched in the European market (maturity stage) and we believe that there is also a demand for it in the American market as mentioned in the previous market analysis, our organization is already grown up, and has the required capacity to think global and act local. Following this strategy, we have to concentrate on local requirements. The American market mainly consists of companies with a large capacity and a focus on mass production, the same conditions as in the European market. Consequently, this market requires a comparable solution which is easy to establish and with flexible capacity. At this stage we can decrease costs by involving intermediaries in the American market for a successful communication and reach a larger distribution on the target market.

3.8. Budget

Our project's marketing budget is about 5000€ for the first year. This budget forces us to be very careful and select those channels that we believe are the most suitable. Some of the activities listed below can be done by ourselves. We defined the following activities, which are covered by our

budget:

- Website
- Collaterals
- Magazine (case study)
- Trade show
- Presentation at selling events

Website and Collaterals can be administered and designed from by one team member as mentioned above. The printing of about 1000 leaflets costs around 400 €, and the website domain has to be bought [26] [27]. With the usage of the case study mentioned in the promotion strategy we are able to save costs. Joining a trade show with an independent stand (acting as exhibitor) cannot be managed with our given budget. Therefore, it is our objective to join trade shows together with one or two partners. Also these costs are in progress as well as numbers for presentation at universities and selling events.

3.9. Controls

Monitoring the marketing plan is one of the most important tasks in order to be successful and to achieve results. No planning without control. Marketing control is the progress of monitoring the plans as they proceed and adjusting where necessary. In this case control parts need to be taken in consideration. Effective controlling consists of several tasks starting with the right characteristics of defined key performance indexes and is to be finished by taking corrective actions. The affected indexes should be flexible and adjusted to internal requirements such as management. In our case the actual performance of the solar dryer has to be controlled and compared to similar products in order to set standards. Referring to our project, we also have to pay attention to technical changes in order to early identify future trends. Benchmarking could be a good sufficient tool for this kind of analysis. As a result of this we, either are able to set standards or if needed take corrective actions. For instance, the customer care and even the after sales service should regularly clarify the prevailing situation. This could be done through surveys in an email or by our call centre. Controlling components concerning our project are the following:

- Sales analysis
- Market share analysis
- Quality control
- Customer Relationship Management (CRM) system
- Service levels

Resources to measure and monitor these approaches are scarce and costly. Consequently it is really important to work efficiently in order to set the right standards and take the right corrective actions.

3.10. Conclusion

Marketing is the process of identifying customer's requirements in order to adjust and develop the organisations strategy successfully. Therefore we did a market analysis which shows that our main target market is placed in Europe and America. The demand for a solution such as the solar dryer exists. Comparable solutions is not available and most of the existing solutions are inflexible and without a variety of functions. A suitable segmentation as well as strategy are the reasonable basis to implement defined objectives. To enter the European market our product needs to be adjusted to future needs. To achieve this we are going to sell our product to universities first. Through an appropriate collaboration it is our aim to create a solar dryer which is adjusted to future requirements such as large function variety, easy to establish, meet the customer's sustainable approach, runs only on solar energy, and has less energy consumption. With a continuous enhancement we believe that we can meet the long-term requirements of the energy market. In order to react on upcoming questions directly we want to sell our product in a direct distribution in this case via Business to Business. This way of distribution (direct) gives the opportunity to control the whole process including the face-to-face contact which is really important because our solar dryer is still a specialized product.

With the usage of an customer oriented service such as Customer Care and an on-going product development we will gain the needed know how as well as customer loyalty to launch our product. All in all we will develop a solar dryer with low energy consumption to replace current systems, adapted functions for specific requirements, and specialized service.

4. Sustainability & Eco-efficiency

4.1. Introduction

Nowadays, the matter of saving our planet is of great importance. People get more and more conscious of the possible dangers and threats towards environment. Due to that, all the producers and manufacturers of all the branches of industry think of ways to create new products in an ecologically friendly manner. Our project focuses on developing a new project, hence we want to create it and make it as environmentally harmless as possible. Due to that, we made a thorough research on already existing companies present at our field of interest. What we found out is that all of current algae drying companies creating different kinds of equipment like centrifuges, use and waste a lot of power in order to get the algae dry. The aim to be competitive on the market forces us to attain one of possible directions: either we mostly focus on drying algae faster or we make it as energy efficient as possible. We decided to follow the second idea. Thus, we create the algae dryer completely dependent on renewable source of energy – solar power. However, not only is our device energy – efficient, but also the greater idea behind it is very sustainable. An algae dryer serves for drying algae, which then can be used to create biodiesel, extremely advantageous as far as current excessive fuel consumption is concerned.

4.2. Biodiesel

It is already widely known that the planet is running out of its fuel resources. Due to that people are searching for alternatives for oil and transportation fuels in general. One of such solutions is biodiesel obtained from microalgae oil. In order to extract such oil, microalgae must be first selected, grown up and harvested, which may be implemented in numerous ways. And here lays the importance of our

project. One of the methods is drying algae in order to get rid of the unnecessary water. Then, the oil must be extracted, which again can be done in different manners. Later on, such bio-fuel would be transformed into biodiesel. The diagram in Figure 12 represents the simplified process of obtaining biodiesel from micro algae [28].

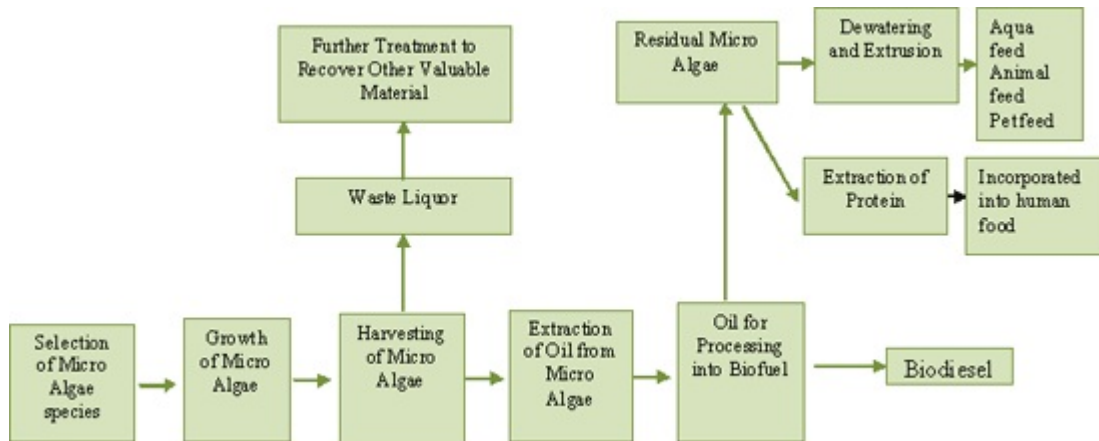

Figure 13. Process of biodiesel receiving [28]

Observing the presented diagram, we may also notice that any side products or leftovers of the process can be reused or recovered. This proves the eco-friendliness of algae cultivation. There are also numerous other microalgae sustainable properties. For instance, they are able to grow almost everywhere. What is more, different species can easily adapt to the diversity of environmental conditions. Thanks to that they are very competitive to other energy crops used to produce bio fuels (rapeseed, corn, soybeans). Their competitiveness justifies also the fact that one can return 10 to 100 more fuels and use from 49 up to 132 times less land area growing algae comparing to already mentioned crops. The table below (Table...) presents the lipid content and productivity of microalgae in comparison to other energy crops. It is clearly visible that microalgae have a great ascendance as far as oil content and biodiesel productivity are concerned, having the lowest area consumption at the same time.

Table 14. Comparison of microalgae to other biodiesel crops[29]

Table 2
Comparison of microalgae with other biodiesel feedstocks.

Plant source	Seed oil content (% oil by wt in biomass)	Oil yield (L oil/ha year)	Land use (m ² year/kg biodiesel)	Biodiesel productivity (kg biodiesel/ha year)
Corn/Maize (<i>Zea mays</i> L.)	44	172	66	152
Hemp (<i>Cannabis sativa</i> L.)	33	363	31	321
Soybean (<i>Glycine max</i> L.)	18	636	18	562
Jatropha (<i>Jatropha curcas</i> L.)	28	741	15	656
Camelina (<i>Camelina sativa</i> L.)	42	915	12	809
Canola/Rapeseed (<i>Brassica napus</i> L.)	41	974	12	862
Sunflower (<i>Helianthus annuus</i> L.)	40	1070	11	946
Castor (<i>Ricinus communis</i>)	48	1307	9	1156
Palm oil (<i>Elaeis guineensis</i>)	36	5366	2	4747
Microalgae (low oil content)	30	58,700	0.2	51,927
Microalgae (medium oil content)	50	97,800	0.1	86,515
Microalgae (high oil content)	70	136,900	0.1	121,104

Moreover, algae are so called “bioremediation agents”. Meaning, they are able to absorb significant volume of CO₂, which makes them very beneficial as far as fighting excessive emission of CO₂ is concerned. In addition, they are also able to get rid of the dangerous nutrients and toxins from wastewater and sewage by growing in the polluted water and using the contaminants as nutrients. The simple scheme in Figure 13 demonstrates the microalgae cultivation cycle. As it can be observed, the continuous process is purely sustainable [28][29].

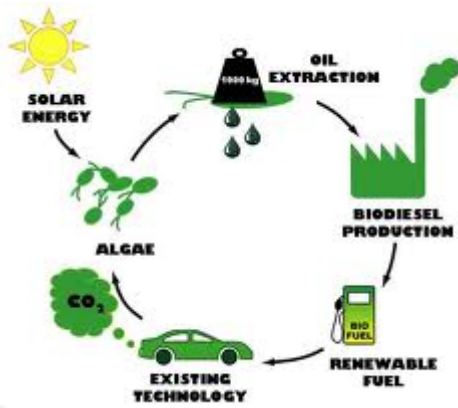

Figure 14. Biodiesel development cycle [28]

4.3. Sustainability

4.3.1. The importance of sustainability in our project

According to Oxford Dictionaries sustainability means “conserving an ecological balance by avoiding depletion of natural resources”[30]. Other sources, for instance, the World Commission on Environment and Development claims that sustainability is to meet the needs of the present without compromising the ability of future generations to meet their own needs[31]. Generally speaking, the common understanding of sustainable engineering and development, which cannot be rigid, is facing humans needs, yet not deteriorating the Earth at the same time. Essentially, our project serves this mission. Not only does it use a renewable source of energy to run the system and recyclable materials, but it also concerns the development of a system to harvest microalgae, which may be used to produce bio fuel.

4.3.2. Main aspects of sustainable production

Sustainability consists of three main pillars: environmental, social and economical one. In these broad fields one may point out several requirements that must be met so as to work for a real sustainable development. With the purpose of describing those areas in terms of our project, it is necessary to distinguish two possible ways of consideration. First, sustainability as far as the algae dryer prototype (main product of our project) is concerned. Then, its production on a larger scale. Taking into account the fact that the real sustainable conditions of such product are currently unavailable, our considerations are so far only probabilities and estimations.

We will start by approaching the environmental criteria of the sustainable development of the product we propose. In order to introduce it into the production of the design, it is advisable to follow and take advantage of several approaches and tools. Firstly, the concept that sustainable development has to be able to renew the resources at the same or greater rate than the pace at which they are consumed [32]. This concern brings our attention to the renewable sources of energy, which usage will be described later on in this section. Furthermore, life cycle analysis make it possible to obtain a good overview of the product impact on the environment. Such an assessment can also be found in the proceeding subchapters of this report. Another important issue is the fact that sustainable engineering ought to be competitive to the non-sustainable one. Meaning, the sustainable process outcome and the customer needs of the product must be met at the same satisfaction level as in the

conventional approach to achieve success in the long run. The last, but equally important factor is eco-efficiency orientation. Aiming at production of goods in a sustainable manner, one needs to stick to eco-efficiency assumptions, which are described in the next part of this chapter.

Coming to economical issues, people not only need to be aware of the invested amount of money, but also of the operational costs of the device. In order to minimize expenses, we will use as many as possible accessories already available at ISEP. Most of the accessories needed are taken from the university. The running costs are also low. That is due to the fact that device is run on the solar energy, hence the solar algae dryer is completely autonomous as far as using other, to be paid, sources of energy are concerned. Taking mass production into consideration, it is equally important to buy necessary materials at local suppliers to limit time and transportation expenses. Thinking of our design even broader, we may be a contribution to investigation over alternative sources of fuel. Such market field is at its peak nowadays and may be very beneficial. If the product gets accepted by Universities, we may even consider sales network.

The last part is the social concerns, which involve not only growing issue of being ecologically friendly, but also getting involved in research over alternative sources of energy. The social factor also stands for securing the future. By being a part of such venture, we make ourselves and others willful of ecology protection and aware of potential threats to the future of our planet. What we are also doing is rising the current generations with the environment consciousness in their minds.

All of the presented sectors are interrelated and cannot be executed separately. It is important to take care of all the aspects in order to achieve good sustainability practice.

4.4. Eco - efficiency

The eco-efficiency is basically increasing the production of goods with reduction of resources, pollution and waste input. According to the World Business Council for Sustainable Development being eco-efficient is wise as far as business issues are concerned. One may conclude that attaining eco-efficient attitude is allegedly a tool companies could follow in order to run business strategies towards sustainability. In accordance to World Business Council for Sustainable Development [33], eco-efficiency can be considered in seven broad perspectives. We present a brief overview of our design with regard to those general objectives.

4.4.1. A reduction in the material intensity of goods or services

This first aspect include decreasing utilization of materials, water or land. As far as these criteria are concerned our aim is to recover the water from algae drying rather than using more of it. Taking into account materials and usage we would like to present two perspectives, first considering building the prototype, second regarding building our product on a larger scale[33].

4.4.1.1. Land

Let us first start with usage of land. The area occupied by the dryer prototype equals to around 0,5 m². Such area is devoted to dry 5 l solution of microalgae. If we assume that replicated product would be able to dry 50l of solution, we may estimate that the total area needed for solar algae dryer would be equal to 5 m². Those numbers on the other hand do not mean one needs to devote the land to

install the device. Our aim is to make the design portable, so that no land needs to belong to the algae dryer both as for prototype and large scale product.

4.4.1.2. Materials

As far as prototype building is concerned, we tried to take advantage of as many parts available at our university as possible. These include the pallet as a support, some electronic parts, pipes or plastic containers. Considering large scale product, we foresee buying needed materials in large quantities and store it in the production magazines. We are designing a product, which does not involve any material production, but only assembling already existing parts. All the issues connected to the material disposal, so for instance recycling and utilization are presented in the following sections of this chapter.

4.4.2. A reduction in the energy intensity of goods or services

As for energy, our project implies creating solar algae dryer. Due to that all the appliances that need energy to operate (fans, ultrasound water level controller, temperature sensor, diodes, micro controller and step motor) are run by the solar power caught by solar panel placed on top of the tank. The placement of the solar panel is shown in the Figure 15.

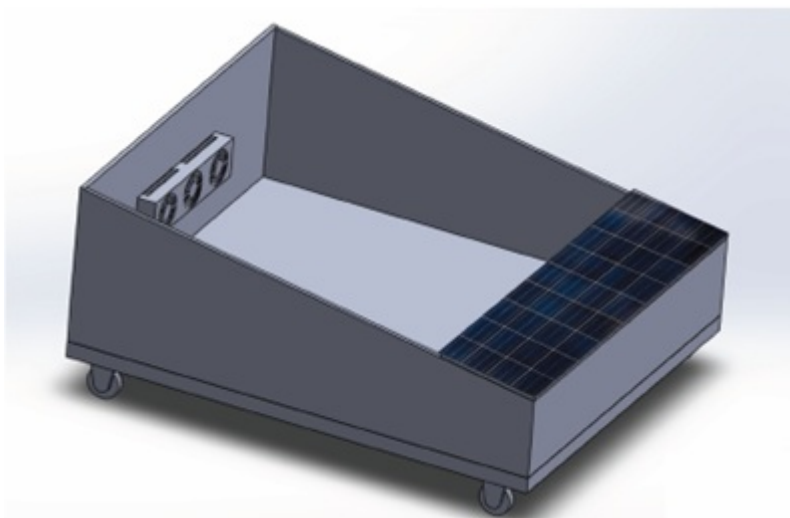

Figure 15. Placement of solar panel

15 W solar panel aimed to be used in the prototype was 15 W powering the 12 V battery, which eventually would run the whole system. The concerns accompanying use of renewable source of energy is presented in proceeding subchapter.

When referring to energy, one cannot omit the battery used in our device. As far as prototype is concerned, the 12 V sealed lead acid battery was supposed to be installed. As this one was offered by ISEP, no other options (in prototype) have been considered.

Taking into account the sustainability issues, various parts of the lead acid batteries can be fully recycled. More detailed description is given in following part of this chapter. Moreover, lead acid batteries are used for off-grid systems, hence they are important components of the systems based on renewable sources of energy. On the other hand, the materials used in batteries structure are lead and sulphuric acid, which are hazardous substances and require extremely safe handling [34]. There

is no harm for the environment when using this kind of batteries as long as they are wisely disposed.

Nevertheless, our product eventually is run by 9 V alkaline battery, shown in Figure 16. This choice was good as far as running the system is concerned, but unfortunately not concerning sustainability. The battery we decided to use is not rechargeable, but since we do not know what would be its operation performance, it is hard to judge whether the solution is sensible or would require frequent battery replacing.



Figure 16. Battery used in the product

When considering a large scale product probably the best option would be to choose already mentioned Li-ion power storage. These are less environmentally harmful, as they do not contain hazardous elements as lead acid do. Moreover, they have high energy density, so the measure of how much energy the battery can hold in comparison to given lead acid, which can be seen on the chart below (Figure 16).

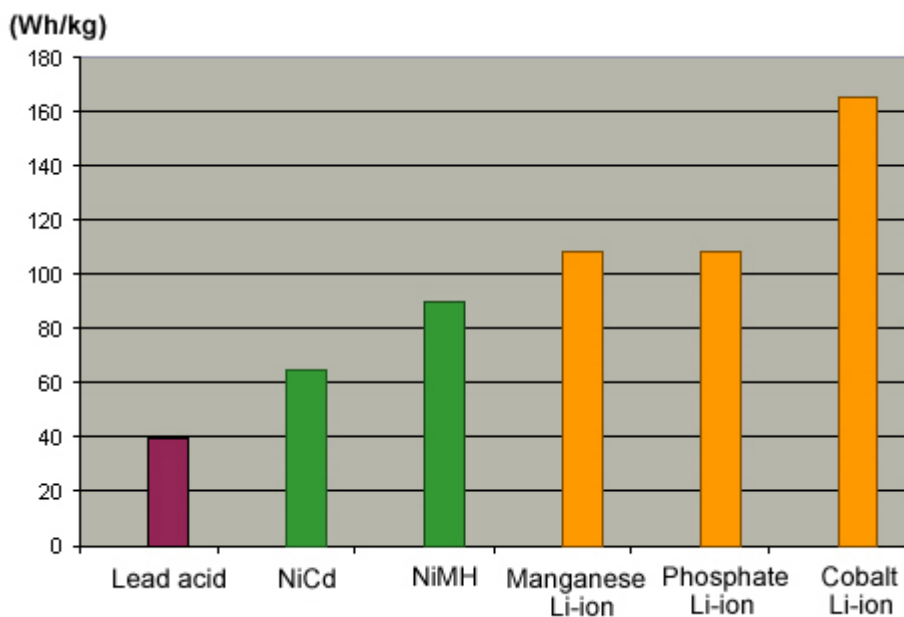

Figure 17. Energy density performance of batteries [13]

In addition, Li-ion recycling technology is now developing, so they seem as a proper future solution. On contrary, one of the obvious disadvantages of Li-ion batteries on the other hand, is the high production costs, which contributes to high price.

Concerning the energy needed to produce the device, we are planning to run an assembling system. We would store necessary parts and connect them together. We reckon that assembling process will not be very energy consuming. The most energy requiring process will be cutting of PMMA to create tank. The microcontrollers may have to be programmed, hence source of energy to run computers will be needed. Yet, we assume that these kind of operations can be included within running costs of the

factory.

4.4.3. Reduced dispersion of toxic materials

This feature of eco-efficiency involves reduction of any kind of polluting emissions or water discharges. It also includes waste disposal and getting rid of toxic substances as well as maximizing involvement of renewable resources usage. The main concept of our project involves using solar energy, therefore a renewable source of energy. The only “waste” or rather side effect of algae harvesting in our distiller is evaporated and then condensed water. Even though water recovery is not integrated into our device, there are plenty of methods allowing this process that could be easily applied in the future [33].

4.4.4. Improved recyclability

Trying to attain real sustainable attitude towards the creation of our product, we took care of its recyclability or at least reusability of parts. The recyclability criteria may refer to solar panel, plexiglass, from which the tank is made and battery.

Recycling of lead acid battery involves recycling of its parts. For instance, the sulfuric acid is purified and recycled. In addition, the lead plates can be melted, refined, and then recycled. The plastic case is shredded and recycled [35]. According to Battery University over 50% of the lead acid battery supply comes from recycled products.

Concerning the recyclability of the battery we decided to use eventually, they are usually not recycled. Unfortunately, even when they are a subject of recycling, the process consumes a great amount of energy and is very expensive.

Mentioning Li-ion batteries (possibility for the future), Figure 18 shows simplified recycling process of such batteries using their own Umicore technology.

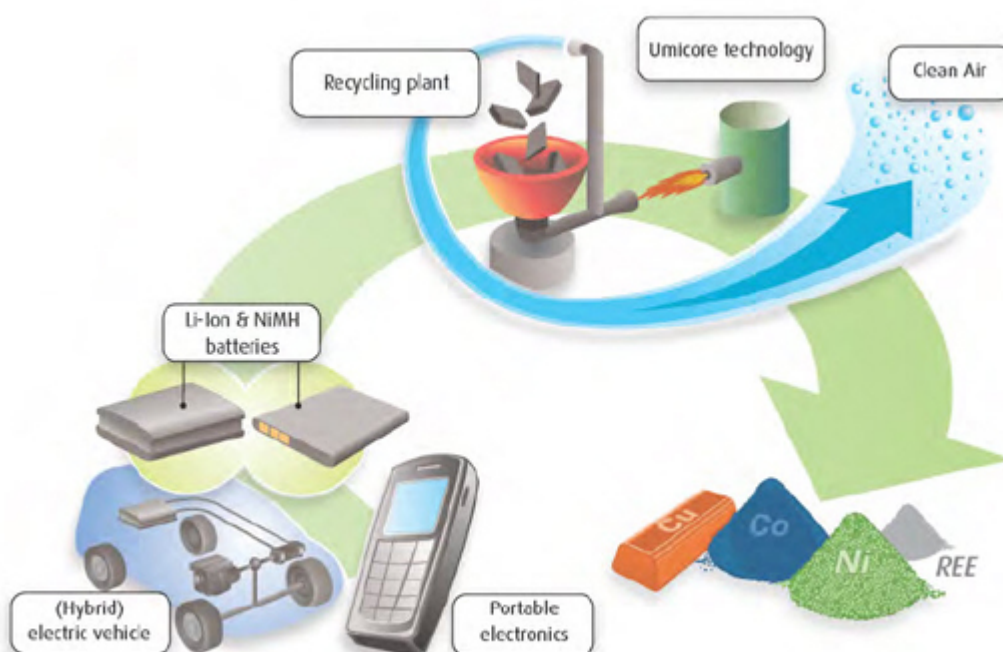

Figure 18. Recycling of Li - ion batteries [36]

Allegedly, the process does not include production of any kind of poisonous waste.

As far as solar panel recycling is concerned, 90% of solar panel is made of glass, which is completely recyclable. Coming to the plexiglass, the material obtained from recycling process can be reused in 100 %. What is more, a lot of materials that we use for building our prototype are provided by ISEP, hence we make sure we do not buy unnecessary parts. Further on, we hope one may take advantage of the part of our design [33].

4.4.5. Maximum use of renewable sources

As already mentioned the idea of our product implies usage of solar power. 15 W solar panel is installed to run the prototype. Considering the replicated product, we believe all the electrical appliances would require more power, hence the bigger solar panel should be used. Then the question arises, is it more sustainable to run the device on the solar power or simply connecting it to the casual electricity grid. In order to answer this question many aspects must be considered. Firstly, we would have to consider production of the solar panel itself. According to the survey run by Sherrell R. Greene, Vice President for Consulting Services at EnergyX posted at his blog [37], we may notice that CO2 emission from solar electricity generation is not significantly lower than natural gas, coal or oil resources. The results of the survey are presented in the graph below (Figure 19).

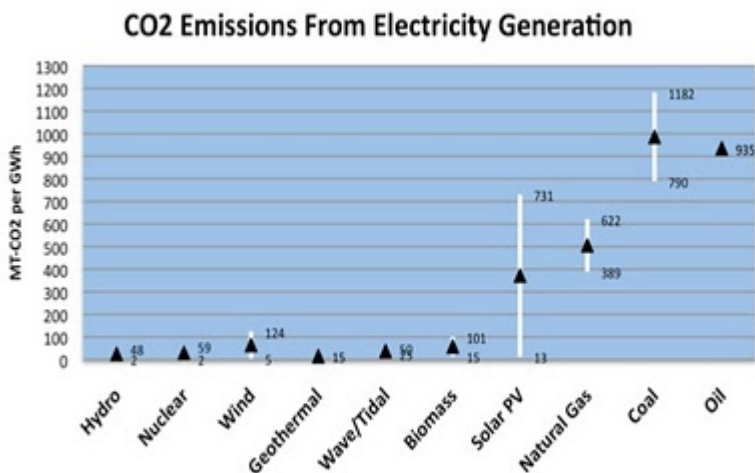

Figure 19. Emission of CO2 from electricity [37]

These results would force us to check what kind of electricity generation the potential customer uses. Taking into account the fact that the potential customer would be universities in Europe running tests on algae oil production, we may assume that it is possible that they would use renewable sources of energy to create electricity. If not, it is also possible that energy consumed by the device would not significantly affect the power consumption of a certain university lab. It is also wise to mention that any kind of electricity generation it is, the equipment installed would require so little energy that it would not be significant for university grid usage. What is more, 15 W solar panel would not support the devices fully. Thus, more powerful solar panel would be needed. As our projects aim was to use solar power, we decided to minimize the number of fans to one in order to reduce power consumption.

The other concern is time consumed during distilling process. Usage of solar power lets us dry the algae solution only during summer and sunny days. On the other hand, device connected to the grid would be running constantly, whole year long and 24 hours a day. Assuming such performance, we would have to check the energy consumption of the replicated product. The customer would have to decide if it severely affects the electricity costs. What is more, the mentioned time of exploitation of the solar algae dryer would also be dependent on the client. It would be advisable to check whether the operation mode of the equipment could be seasonal.

The other important factor is the principle of operation. Our solar distiller is aimed to evaporate water from algae solution. In order to do that we use direct solar radiation. Solar energy is used only to support electrical appliances. Hence, the equipment must be placed outside. So as to connect the device to the grid, one may have to use extension rods. That would require investigation over the production of such parts and taking care of safety issues.

The last concern would be battery usage. When considering replicated product, the battery may become quite an important issue. Obviously, if connecting the equipment to the casual current unit, the battery will not be needed. However, if solar panel would still be used, one may have to be aware of the adequate battery installation. Allegedly, nowadays, the most ecologically friendly power storage solution is Li-ion battery. In order to decide whether to install such battery or not, one may have to think of the recharging process, of recyclability and safety issues concerning exploitation of Li-ion battery. Such batteries are already broadly used in e-cars, so ones run by electricity.

Concluding this discussion, there is no straightforward answer to the given problem. The first step that would have to be taken is conducting the thorough research on customer (European universities running test on algae oil extraction) needs. Moreover, it would be necessary to run several test on the large scale product using solar panel and ordinary electricity grid to get the answer in numbers. It would also be helpful to compare in numbers the CO₂ emission from electricity generation of solar power, the type of electricity power that the customer uses and while producing extension rods equipment. Yet, as far as prototype is concerned, we believe that connecting our solar algae dryer into the grid would be more sustainable. On the other hand, since we have been aimed to create a device run on solar power and such that can be replicable (we cannot exactly tell whether solar panel is not a sustainable solution for larger scale product), we decided to install 15 W solar panel and reduce number of power consuming fans.

4.4.6. Greater durability of products

Our product durability would be dependent on the proper usage. What is more, taking into account the fact that our product would be placed outside, weather conditions may also contribute to worse durability of the product. Since, we are only assembling the parts, we make sure that the materials used in production are claimed, by producer, to be durable.

4.4.7. Increased service intensity of goods and services

According to World Business Council for Sustainable Development this concept means adapting to the real customer's needs and incorporating additional features to the product. Thanks to that those needs may be fulfilled within one product, spending fewer materials and resources. We would like to work on incorporating water recovery, automated algae removal and enhanced algae charging and attraction system into our product produced on the large scale [33].

4.5. Life - cycle analysis

Life - cycle analysis or assessment, presented in Figure 20 is an extremely helpful tool while trying to measure the real impact of our product on the environment.

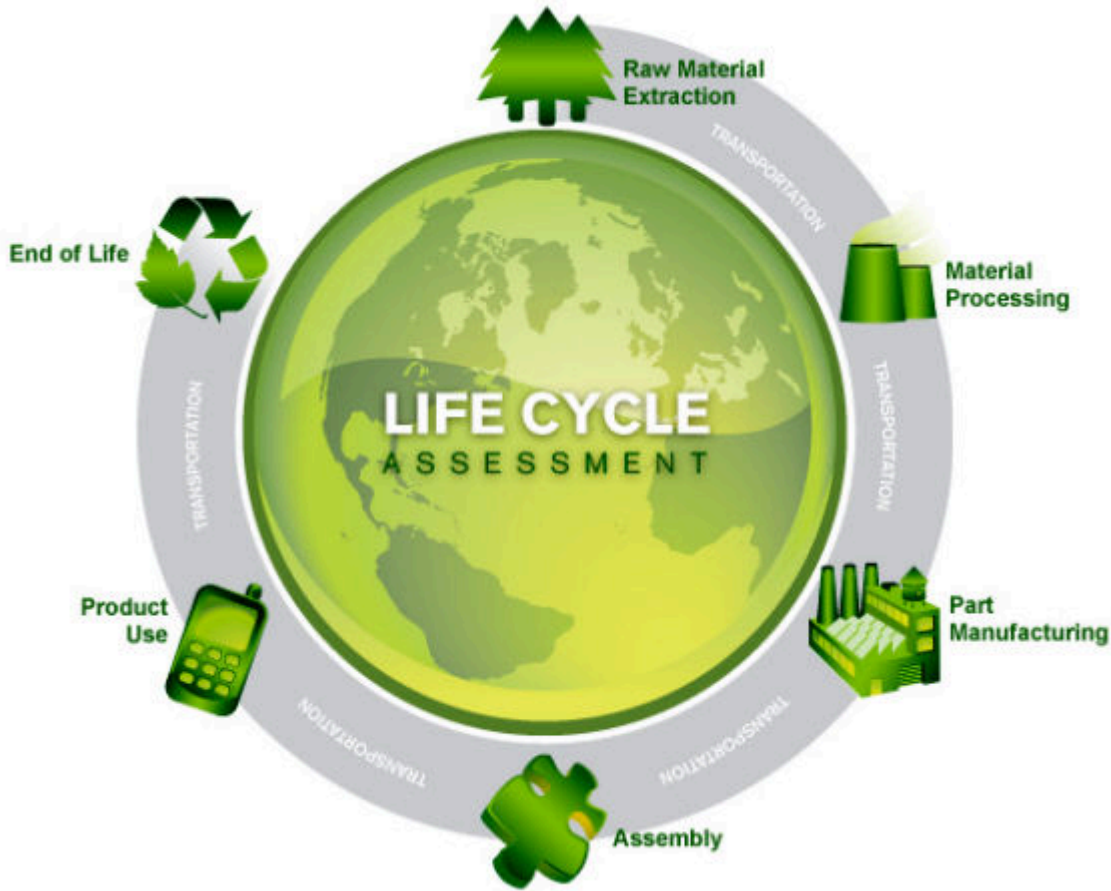

Figure 20. The process of life - cycle [38]

Such assesment consists of several steps. The first one is the analysis of the raw material extraction. Then, focus may be put on processing the materials. The next stage of life-cycle consideration is manufacturing of needed parts. Afterwards, we reach the assembling process. The two steps left are the product usage and its life end. Taking into account the device we are creating, our position is at the assembly process. We are buying already existing parts and elements to build solar algae dryer. Materials needed to produce our distiller are as following: Poly(methyl methacrylate) also known as plexiglass, mirror serving as reflector, devices: ultrasound water level controller, water proof temperature level sensor, fans, solar panel, 12 V lead acid battery, micro controller and step motor controlling blinds. The remainings are parts needed to assemble the whole structure like: glue, pipes, valves, etc.

As far as life - cycle analysis is concerned we would mainly focus on the stages starting from assembly process. Yet, we will show the previous steps for plexiglass.

PMMA, also known as plexiglass can be seen in the Figure 21 below.

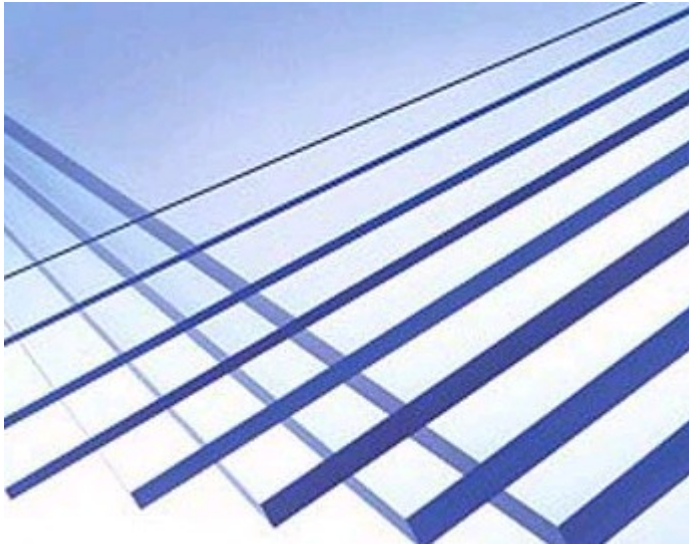

Figure 21. Plexiglass [50]

Raw material for plexiglass production is polymer of methyl methacrylate that can be developed in laboratory and does not need the presence of any endangered natural resources. Moreover, part of its production right now is created from recycled plexiglass. The processing of the material requires its heating up, but no harmful air emissions were noted during this process. Afterwards, the material can be either molded or extruded, which again does not cause pollution. Coming to assembly process, PMMA must be first cut. This proceeding is usually done by usage of laser. Unfortunately, some amount of CO₂ is released during this process. The glue used to join the parts together is Cyanoacrylate, the substance that may irritate sensitive membranes of human body. Hence, its use must be controlled and performed in well ventilated areas. Nevertheless, this product makes no environmental harm. In the end of its life, plexiglass may be and is commonly recycled [39] [40].

When examining the whole device, it is wise to consider the stages starting from assembly process. This is the step, where our project gets involved into the life-cycle process of the used materials. Assembling the solar algae dryer requires physical input and using already mentioned “superglue”. Our aim would be to limit the transportation involvement as much as possible. In order to do that, we would like to buy plexiglass and mirrors in large amounts at the local suppliers store in this way reduce transportation frequency and cost. What is more, our plan is to be able to buy all the needed electrical appliances at one producer, which serves the same goal.

Exploitation of the product may have different ecological impact depending on the choice of either using solar panel to run the device or connecting it to the grid as already described in the previous section of this chapter. The only waste produced while using the distiller would be the water from microalgae solution. End of the product life may be caused by two possible situations. The first possibility is that the equipment is no longer needed. In such situation, almost 100% of the parts may be either recycled (plexiglass, battery, solar panel, fans) or reused (mirrors, step motor and blinds, valves, pipes, controllers, micro controller or diodes). The other option is to reach battery’s end of lifespan. If so, the most sustainable way would be to recycle the battery and get the new one to reuse the equipment again.

4.6. Conclusions

To sum up, sustainability issues gathers numerous questions to be answered and a great deal of effort. Yet, it is gaining more and more popularity. In solar algae dryer, the whole great idea behind it

makes it already sustainable. Playing a role in algae harvesting contributes to research and obtaining bio-alternatives to transport fuels. It is important to cultivate algae as they have a number of advantageous properties that may contribute to minimize harm done to our planet. In order to call our project sustainable, we would have to fulfill the three joint pillars of sustainability. That means we would have to make sure we are able to meet environmental requirements, social and economical ones. The possible mass production of our device would have to comply with an eco-efficient attitude towards production and keep in mind life – cycle analysis of the replicated product. We conclude that it is extremely important to use recyclable or reusable materials and renewable sources of energy. It is also worth attention to limit the waste production and its disposal. We believe that the matter of being ecologically friendly is a major issue nowadays.

5. Ethics and Deontology

5.1. Introduction (legal thinking)

In this world we are with seven billion people and all with a different background. This means we have different religion, different moral and ethical standards, different courtesy rules and etiquette and different legal norms. The solar algae dryer, we are developing will be conform according to the laws listed above.

Sources of the Law: The sources of law are modes of formation and revelation of legal rules in a particular jurisdiction. There are two kinds of sources. The first sources are the direct ones. They create legal norms. The indirect sources are the second kind of source. They do not create but they contribute to the formation of legal norms.

- Law

Law can refer to multiple items. Law in the wide sense refers to all the acts that establish legal rules. The law in the strict sense refers to diplomas issued by the Portuguese Parliament.

There are different kinds of laws and there is a hierarchy between them. At the top you have the Constitutional Law. It is followed by Law and Decree-Law, Decrees and the last one is Ordinances and Normative Dispatches. (Figure 21)

- Custom

It consists of a constant social practice with a sense of obligation.

- Doctrine

These are studies, review and opinions from juriconsults on the interpretation, integration and application of the law.

- Jurisprudence

This implies court decisions.



Figure 1

Figure 22. Different kinds of laws [51]

52. Ethics and deontology in Engineering

5.2.1. Engineering codes of ethics

As future engineers we have several duties. Our first duty is to the community. By making a solar dryer for micro algae, we are contributing for, namely developing bio diesel. This is how we fulfill our duty to defend the environment. The users' safety is ensured because mechanical processes are not used. There is no cutting, punching, sawing of anything dangerous involved. Therefore the risk of staff performers or users to get injured is very low. We studied a lot of different separating techniques and compared their advantages and disadvantages. For every objective the best possible solution was looked for, considering economy and quality. By searching for the best technical solution, the duty of competence and suitability was fulfilled .

The second duty to be fulfilled is towards the employer or client. We contribute to the economic objective by making the dryer very energy efficient. Even though it is not the fastest solution, it is the greenest and most efficient one. Because this is such a green solution the improvement of product quality is promoted. The dryer performance depends on the sun, so we can only ensure its operation when the sun shines. But when there is enough sunlight, the dryer will always work. Another aspect in our duty to the client is charging only the services we actually rendered, considering its fair value. Before we started to create the dryer the client gave us clear requirements concerning, for example, its capacity and speed. There was also a maximum budget given. The maximum budget will not be spent; the client only pays for the components we buy.

The third duty we have to fulfill is the duty to the profession. We fulfill this duty by planning our project properly, and by delivering it in on time. While we are working on this project, we are also acquiring knowledge about new techniques and how to absorb them into new ideas. We also fulfill this duty by maintaining a good communication between the client and our team. We oppose unfair competition by not copying existing work, by not using patented technology nor software we have not paid for. We have to protect the idea that we develop for our client from other companies. An element of the duty to the profession is the duty of sobriety advertising. But since we don't advertise for our product, this duty is not applicable. Since this is a school project it is up to us to prove that the project lies within our competencies and that we are able to deliver within the time constraints.

The fourth duty is the duty to our colleagues. We discussed group attitude rules and what will happen when there is a disagreement between group members. We talked about the sense of leadership, specific roles in our group, the difference between outgoing and ingoing persons, making decisions anonymous or unanimous, how to deal with our feelings within the group, among other aspects. In the

end we choose three group attitude rules. 1. "One achieves the most of all group members' function can be discussed and criticized openly." 2. "Everybody should be given an opportunity to speak up and express his/hers views until he/she feels he/she is understood even if it takes a long time." 3. "It's better to accept compromises than to discuss disagreements."

So we know we can speak up and criticize each other without taking it personally. Of course the criticizing should happen within certain common boundaries. We also respect each other's intellectual property. We understand we all have a duty to cooperate and give assistance when one of the team members requests for it [41] .

5.2.2. Professional ethics model

Minimalist Model: The engineer is only concerned with meeting standards and requirements of the profession and any other laws or codes that apply. The model looks for a fault when problems or accidents arise.

Due-Care Model: The engineer had to take reasonable precautions or care in the practice of his profession. The goal of the model is to prevent harm.

Good Works Model: The engineer goes beyond the basics of what is required by standards and codes. They try to improve product safety, social health and social well being.

So the feeling of responsibility of the engineer is the greatest in the last model and the smallest in the first model.

We are following the Due-Care model because safety is not our main goal but it is a goal. We think it doesn't have to be our main goal because our project doesn't include dangerous techniques like cutting or punching. However, we do understand the importance of safety.

5.2.3. Ethical and deontological problems

We are dealing with an ethical and deontological problem when all the possible solutions might have negative ethical consequences. Luckily we have not been confronted with these kinds of problems during the development of our dryer, so far.

5.2.4. IEEE code of ethics

1. *"To accept responsibility in making decisions consistent with the safety, health and welfare of the public, and to disclose promptly factors that might endanger the public or the environment."*

Everyone has the obligation to not endanger others, but we have a special responsibility because we are creating the products and systems that can harm others. We, as engineering students, are well aware of this responsibility. While creating the algae dryer we have always considered safety. We are also aware of the obligation to speak up when we see something that might be harmful, even if it is not our project or responsibility.

2. *"To avoid real or perceived conflicts of interest whenever possible, and to disclose them to affected parties when they do exist."*

We are able to discuss important matters in our team without creating a conflict, because conflicts or personal disagreements should always be avoided. We made agreements on how to behave in our group and what we should do in case of a conflict.

3. *"To be honest and realistic in stating claims or estimates based on available data."*

We have the basic obligation of always being honest with our client and with our team members. We cannot publish only favourable results, or not perform tests because we know the outcome might not be in our advantage. This honesty is not positive for our project, while not being honest might have serious negative consequences.

4. *"To reject bribery in all its forms."*

We are rejecting bribery in all its forms.

5. *"To improve the understanding of technology, its appropriate application and potential consequences."*

During this project we had to do a lot of research on algae, separating techniques, solar power, distilling and many other related topics. This had broadened our knowledge a lot and maybe will make us better engineers in the future. But as engineers we will have the duty to inform the public about new technologies and its consequences.

6. *"To maintain and improve our technical competence and to undertake technological tasks for others only if qualified by training or experience, or after full disclosure of pertinent limitations."*

We should only accept jobs that we can execute confidently. But we should not refuse a project where we will do research in new technologies, and we should not only do what we are comfortable doing. For us, students, it is different because we don't have a lot of experience and being a student is about getting more confident and improving our competence.

7. *"To seek, accept, and offer honest criticism of technical work, to acknowledge and correct errors, and to credit properly the contributions of others."*

This code is about the relationship between engineers. It is about understanding that honest critique must be given, and that it is not intended as a personal remark. This also implies that proper credit must be given to others. We talked about this as a team and understand that this is a necessary part of teamwork.

8. *"To treat fairly all persons regardless of such factors as race, religion, gender, disability, age or national origin."*

Not only engineers but everyone has the duty to treat all persons equal.

9. *"To avoid injuring others, their property, reputation, or employment by false or malicious action."*

This also means we cannot spread confidential information such as trade secrets and intellectual property. We didn't receive such information.

10. *"To assist colleagues and co-workers in their professional development and to support them in following this code of ethics."*

We have the obligation to other professions to help them continue, grow and develop. Since we all

have a different academic background we will definitely broaden each other's knowledge [41].

5.3. Liability

5.3.1. Legal liability

Our solar dryer is meeting with following directives:

- Directive 2006/42/EC on machinery
- Electrical Safety: Low Level Voltage Directive
- Restriction of Hazardous Substances (ROHS) in Electrical and Electronic Equipment Directive
- Mandatory adoption and use of the International System of Units

5.3.2. Crime law liability

Since our product is not likely to harm someone this chapter is not applicable. But here follows an enumeration of the possible risks and dangers:

- Risk of getting hurt by lifting heavy things
- Risk of getting hurt by repetitive movements
- Risk of getting hurt by making turning movements causing torsion in the wrist.
- Electricity: risk of getting hurt by direct and indirect contact: electrification (burns) or electrocution (death)
- Risk of getting hurt by a fire because of the stepper motor exploding
- Danger of tripping over a cord.
- Danger of slipping on a wet floor
- Risk of getting hurt by using glass cups, they can break.

5.3.3. Professional liability

See 6.2.1 engineering codes of ethics: the duty to the **profession**.

5.4. Intellectual property law

The technology we use is not patented; we designed the system and the tank ourselves. The method we use for drying the algae is distilling. There is no patent on the distilling method because one of the criteria of obtaining a patent is that the product or method has to be new and different from anything else that is public knowledge. Public knowledge includes anything that has been previously patented, anything that has been written about in a publication or anything that is already being sold in the open market. Our dryer is not patented because we combine existing ideas, so the result can be considered new. A combination of existing ideas can only be considered new if the combination serves a certain purpose, which it does in our case. In this stage we are not branding the dryer but it should be done in a later stage [42].

6. Project Development

In this chapter we describe the general parts of our project, and explain how it works. Here the materials used to build the dryer, its architecture and different modules as well as the functionalities are presented. All the necessary tests done to the device are also clarified.

The Beginning

In the first week of EPS we received a list with all the possible topics. We sat together as a team and talked about all the different topics on the list, and about each other's fields of study. We were all interested in solar energy, so we chose the solar refrigerator. The contrast between warmth, the solar power, and coldness, the refrigerator, was appealing to us.

During the first meeting with the supervisors, we were told that the budget for the solar powered refrigerator was no longer available. So, we opt for the solar dryer since the solar power was also appealing to us.

Development

Then we started to discuss specifications. For example, the budget, the capacity it had to have, the conditions it should work in, functions it should have and other requirements.

When that was clear, we started to look for different kinds of drying methods. After brainstorming we came up with several kinds of methods and decided there were three worth looking into on a more profound level. They were the hydro cyclone, distilling and filtering. We analysed them thoroughly and discussed our findings with the supervisors in a meeting. There, we decided that distilling was the best method for the dryer, because the problem with filtering – the saturation of the membrane – was too hard to solve, and powering a hydro cyclone with a solar panel was also a big issue.

We started discussing during the meetings with and without supervisors how we believe it would work, tried to figure out how we could reach the given goals. We thought about how we should control the temperature: as solutions we thought about fans, blinds and a heat-shielding blanket. In the end, we chose the blinds to control the temperature and the fans to speed up the distilling process. We decided to build the tank out of Plexiglas because of its UV protection qualities.

We were going to use an ultrasound level controller to check the level of the water-algae solution. Another point we had to discuss was if the system should be closed or not: in the end we thought that a closed system would be the best for the dryer.

Purchasing

After determining how the dryer will operate we started to provide the supervisors with pro-forma invoices of all the different parts. Nídia Sá Caetano then gave us permission to buy the needed parts. We talked with the supervisors about the prototype assembling as well.

Testing

During one of the meetings Cristina Ribeiro suggested we should check if the algae had a charge. When we tested it in the lab, we discovered that they were negatively charged. After that test we did another one to see if we could attract them with electrodes. This was not possible, so we tested it with a capacitor and it worked then. When using a capacitor the algae were attracted to the negative side.

But since the project was in a later stage already we decided to not to integrate the extra function in our prototype. We performed more tests with different kinds of voltages and set ups. We discovered that with a higher voltage, 35 V, the separation was faster but that elevating the voltage even more had no noticeable effect on separation rate. But it also worked with a voltage of 12 V, only slower. Since the distilling process takes a lot of time , a lower voltage would work perfectly.

Asembling

When the ordered materials arrived, we started assembling the Plexiglas, the sensors, the blinds, the stepper motor that controls the blinds and all the other parts.

In the end the dryer was finished and the electronic parts were programmed.

6.1. Materials

After deciding on which method to use one of the first things needed to be done, was to assembly the material list. Table 15 presents the complete material list for our project, worked out after thorough research. The available budget for the project was 500 €, but we managed to keep the cost lower.

Table 15. Material list

Quantity	Description	Price
1	Plexiglass (118x126 cm) 6 mm thickness	122.88€
1	Ultrasonic level sensor	-
1	Waterproof temperature sensor DS18B20	8.95 €
2	Plastic tank	-
2	Connecting pipe	-
1	Mirror (20x50) cm ²	
1	Fan 12 V DC	~30.00 €
1	Solar panel 15 W (29,6x50,7 cm)	105,80 €
3	LED-diode	-
1	Battery 12 V	-
1	Stand	-
1	Micro-controller Arduino uno	20.00 €
1	Stepper motor Astrosyn Y129	-
1	Blinds 60x130 cm ²	4.99 €
3	Valve 13 mm	7,25 €
4	Wheels	~20 €

6.2. Architecture

This chapter presents a rough overview of the different parts of the project. These are the main parts

Figure 25. 3D drawing of tank

The tank is the "main" part of our project. It is where we have our solution and it is where the process takes place. We developed our project starting with the tank. After the tank we thought about what parts we have to use for controlling the process, these are the level sensor and temperature sensor. These are connected to the control box (micro-controller), which receives information from the controllers in order to control the cooling down and stopping processes, which are operated by the step motor and the blinds. We also have the solar panel to recharge the battery and the battery distributes energy for all the components. Another important part of our product are the fans inside that help to speed up the evaporation process. There are two different containers, one for the algae solution and one for the evaporated water. This means that we collect all the water and don't let any of it be wasted.

6.3. Modules

The solar algae dryer is based on the plexiglass tank and it consists of different kinds of mechanical and electronic parts and modules. In this chapter we describe these different modules and how they work independently and as a part of the system. Our system consists of three different modules. The drying process block, the controlling block and the power supply block. Figure 26 shows the different modules of the system.



Figure 26. System modules

The drying process takes place in the plexiglass tank. This is where we put our solution, and the evaporation process takes place. We designed and assembled the tank by our own and it is made out of plexi because of the need to be transparent, waterproof, easy to assemble, environmental friendly and cheap.

During the process the evaporated water will rise to the roof of the tank and slide down to the water tank. This way we will recover all the water used in the process. The concentrated algae solution will remain in the major tank and be transported to an algae container when the process is ready.

The second block is the controlling block, this module helps us control the process. Here we have the micro-controller as our major part of the controlling system. For the micro controller we are using an Arduino Uno ATmega328. All parts in the controlling block are connected to the micro-controller, and the micro-controller is communicating and controlling all the other parts.

First we have a waterproof temperature sensor model DS18B20 for measuring the temperature of the water-algae solution. This is needed due to the fact that the water temperature can't rise over 50°C because it would harm the algae. The temperature controller is connected to our micro-controller and gives a signal if the temperature rises over 50°C.

For our stopping process we are using an Ultrasonic Range Finder model Devantech SRF04. The sensor emits high frequency acoustic waves that are reflected back to and detected by the emitting transducer. This is needed for the system to know when the process is ready and the algae are dry enough. When the water level is low enough the Ultra sound sensor will give a signal to the micro-controller and tell it to shut down the system.

The shutting down of the system is controlled by a step-motor connected to blinds. When the temperature rises too high or the process is ready the micro-controller will tell the step-motor to close the blinds in order to lower the temperature inside the tank. Another important part of the controlling process is the fan. It is used for speeding up the drying process. The fan will be connected to the micro-controller, and it will run constantly until the end of the process when it is shut down by the micro-controller.

6.4. Functionalities

This chapter describes how the different functionalities work and how the controlling process are programmed.

6.4.1. Flowchart

The flowchart shows how the program is supposed to work and how it controls the process. The programming part in page 81-84 is based on the following flow chart.

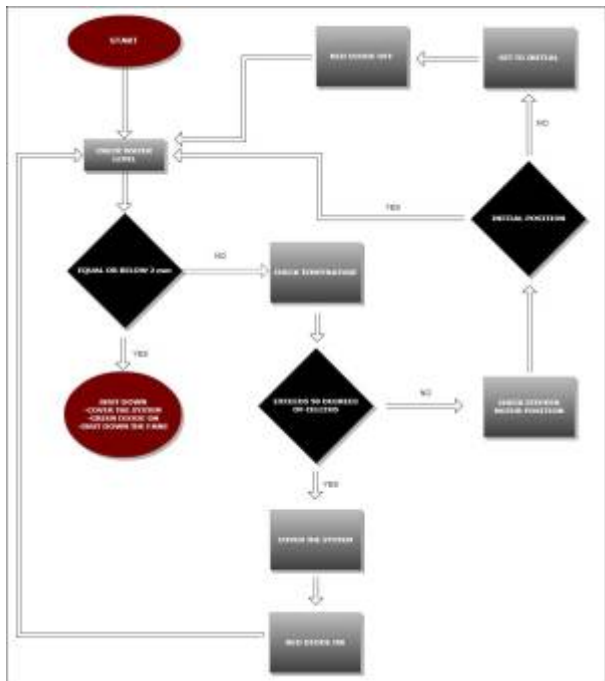

Figure 27. Flowchart

6.4.2. Electrical chart

Figure 28 presents the electrical chart. The presented chart gives an overview of how to connect all the electrical appliances to Arduino Uno board. As it is an example, the pins on the scheme are not the same in the real connection.

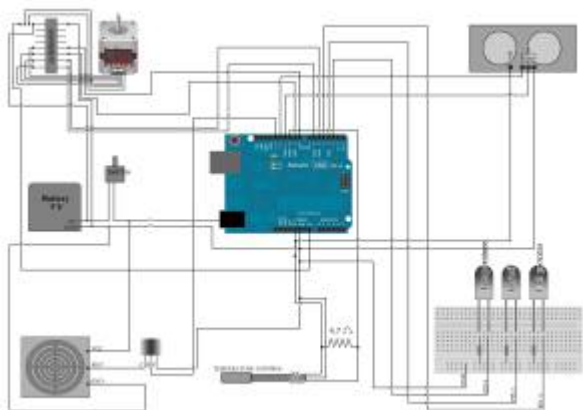

Figure 28. Electrical chart

Some of the mentioned electrical appliances require additional parts to be added. For instance, stepper motor can only be operated with the use of Darlington Array. There is also transistor connected to the fan and resistors joined with LEDs and temperature sensor. The scheme presented on the following page is what we planned to create in the end of the project. Since we did not manage to gather all the needed parts on time (solar panel and fan), our final electrical circuit consists of Arduino Uno board, LEDs, level sensor, temperature sensor, needed resistors, 9 V battery and switch. Because of the fact that we did not manage to obtain a power supply, we could not connect it to the battery to previously planned 12 V battery. We decided to run the system with 9 V battery directly connected to Arduino instead. The illustration below, Figure 29. displays working operation system of solar algae dryer.

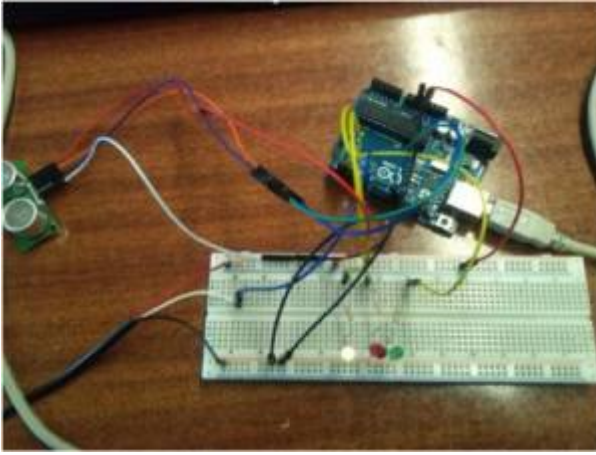

Figure 29. Connected electrical circuit

On the other hand, we managed to run the stepper motor and we conducted a test to check whether our idea of moving the blinds with it is suitable or not. The Figure 30. below shows the possible stepper motor localization for blinds operation.



Figure 30. Stepper motor location

The following Figure 31. presents the connection of stepper motor to the Arduino board.

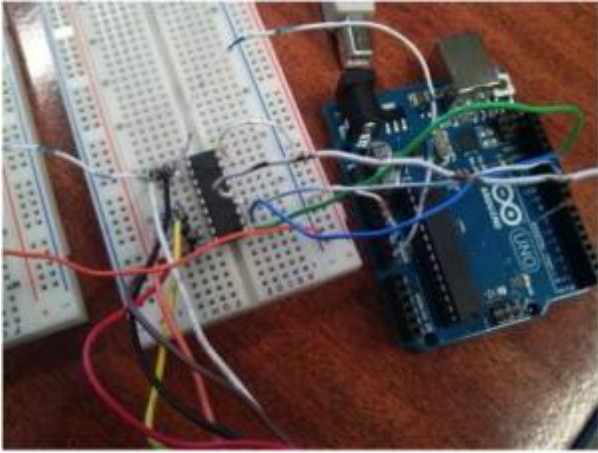

Figure 31. Stepper motor connection

What we learned was that Y129 Astrosyn motor devoted to operate on 12 V is still moving on 5V only. Yet, this much was not powerful enough to move the blinds when motor was bonded with them. In order to connect stepper motor to 12 V, however, we needed additional power regulating circuit shown in the Figure 32. Operating on 12 V stepper motor was strong enough to turn the blinds. As already mentioned our project misses power supply and due to that we decided to omit stepper motor in our system as 5 V supply will not contribute to expected result.

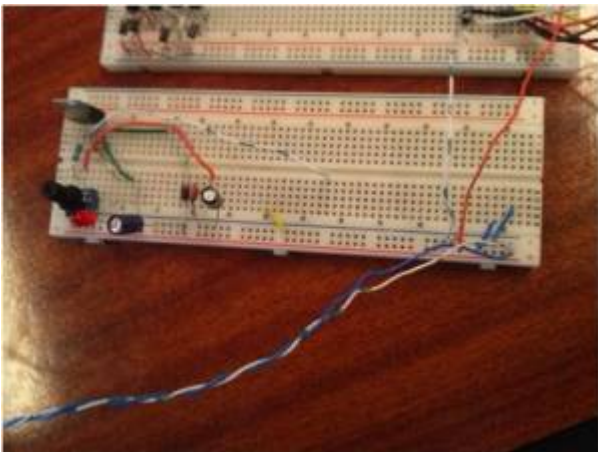
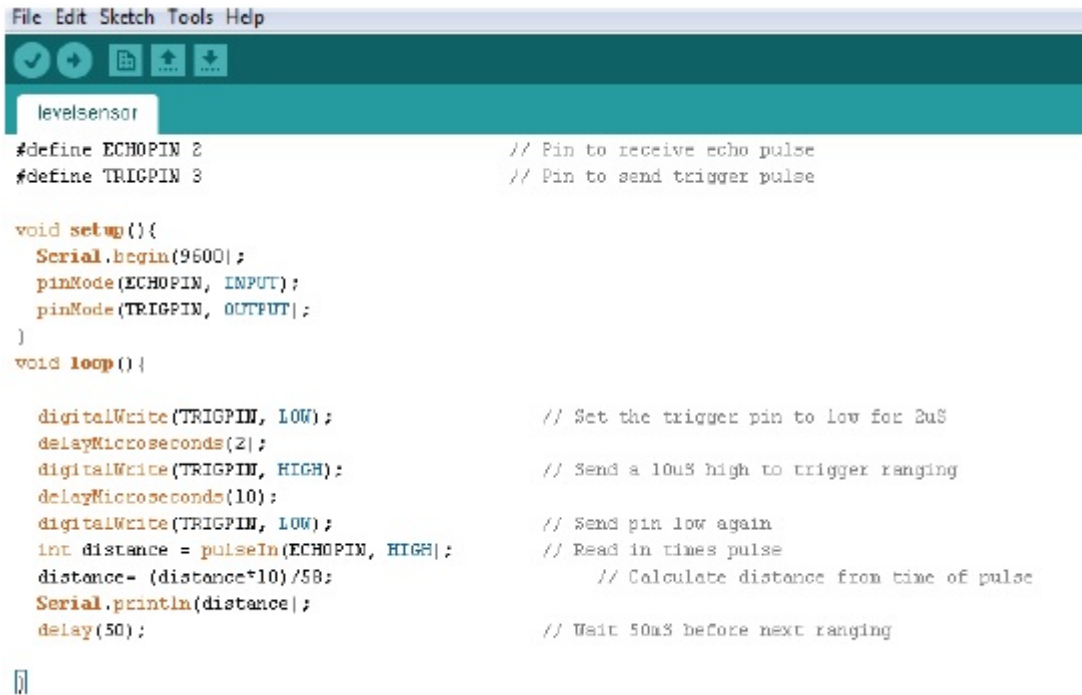

Figure 32. Power regulating system

6.4.3. Programming part

The following figures (33,34) show exemplary parts of program written for Arduino Uno board taking care of running all the electrical appliances. The programs for separate devices were based on sample programs for these special kinds of equipment available online [43].



```
File Edit Sketch Tools Help
levelsensor
#define ECHOPIN 2 // Pin to receive echo pulse
#define TRIGPIN 3 // Pin to send trigger pulse

void setup(){
  Serial.begin(9600);
  pinMode(ECHOPIN, INPUT);
  pinMode(TRIGPIN, OUTPUT);
}
void loop(){

  digitalWrite(TRIGPIN, LOW); // Set the trigger pin to low for 2µs
  delayMicroseconds(2);
  digitalWrite(TRIGPIN, HIGH); // Send a 10µs high to trigger ranging
  delayMicroseconds(10);
  digitalWrite(TRIGPIN, LOW); // Send pin low again
  int distance = pulseIn(ECHOPIN, HIGH); // Read in times pulse
  distance = (distance*10)/58; // Calculate distance from time of pulse
  Serial.println(distance);
  delay(50); // Wait 50ms before next ranging
}
```

Figure 33. Ultra sonic range finder program

The sample program for level sensor used in our project is presented above. The program assigns some Arduino pins to device inputs or outputs. The presented code enables giving out signals by level sensor and calculates the distance from the pulse time value. Afterwards it returns the calculated value.

```

#define TEMPPIN 7

#include <OneWire.h>
OneWire ds(TEMPPIN);

void setup(){
  Serial.begin(9600);
}

void loop(){

  float temp = getTemp();
  Serial.println(temp);
  delay(100);
}

float getTemp(){
  byte data[12];
  byte addr[8];

  if ( !ds.search(addr) ) {
    //no more sensors on chain, reset search
    ds.reset_search();
    return -1000;
  }

  if (OneWire::crc8( addr, 7) != addr[7]) {
    Serial.println("CRC is not valid!");
    return -1000;
  }

  if ( addr[0] != 0x10 && addr[0] != 0x28 ) {
    Serial.print("Device is not recognized");
    return -1000;
  }

  ds.reset();
  ds.select(addr);
  ds.write(0x44,1);

  byte present = ds.reset();
  ds.select(addr);
  ds.write(0xBE);

  for (int i = 0; i < 9; i++) {
    data[i] = ds.read();
  }

  ds.reset_search();

  byte MSB = data[1];
  byte LSB = data[0];

  float Tread = ((MSB << 8) | LSB);
  float Temperature = Tread / 16;

  return Temperature;
}

```

Figure 34. Temperature sensor program [54].

This code requires special Arduino Library called OneWire. The mechanism of operation is based on MSB and LSB, so most significant and least significant byte. Temperature sensor is able to read current value of the temperature and returns it to the mother program.

Next part includes the code concerning the stepper motor. First part was the initialization: defining

the amount of steps per one revolution for our motor, including the library <Stepper.h>. After that the pins were assigned to proper wires of the motor. Int blinds = 0 is an assigned variable to set the position of the blind. In this case value 0 refers to the blinds being open. In the void function OpenBlind the rotation of five revolutions is programmed with rotational speed of ten revolutions per minute.

```
#define STEPS 200
#include <Stepper.h>

Stepper myStepper(STEPS, 8, 9, 10, 11);
int blind = 0;

void OpenBlind() {

    myStepper.setSpeed(10);
    delay(1000);
    myStepper.step(-1000);
    blind = 0;

}

void CloseBlind(){

    myStepper.setSpeed(10);
    delay(1000);
    myStepper.step(1000);
    blind = 1;

}
```

Figure 35. Stepper motor code

Similar approach is seen in CloseBlind function but in a reverse direction. In this case blind variable is set to 1, to show, that the blinds are closed.

There is part of code in the loop shown below, to exhibit how the device will behave whether what the position of blinds is and what value the temperature achieves.

```
if (temperature < 50 && blind == 0);
if (temperature >= 50 && blind == 0) CloseBlind();
if (temperature >= 50 && blind == 1);
else OpenBlind();
```

Figure 36. Stepper motor dependance on temperature loop

Since, we did not manage to run blinds with the usage of stepper motor, below in Figure 37., main running code is displayed.

```
ProgramBezSteppera Highlevel Hightemp LevelSensor Stop_operation TempControl
#define ECHOPIN 13 // Pin to receive echo pulse
#define TRIGPIN 12 // Pin to send trigger pulse
#define TEMPPIN 7

#include <OneWire.h>
OneWire ds(TEMPPIN);

void setup(){
  Serial.begin(9600);
  pinMode(4, OUTPUT); //pin4 red diode
  pinMode(3, OUTPUT); //pin3 green diode
  pinMode(2, OUTPUT); //pin2 yellow diode
  pinMode(ECHOPIN, INPUT);
  pinMode(TRIGPIN, OUTPUT);
  digitalWrite(4, LOW);
  digitalWrite(2, HIGH);
  digitalWrite(3, LOW);
}

void loop(){

  if (readLvl() >= 140) stopOperation();

  else Highlevel();

  getCelsiusTemp();

  if (getTemp() >= 50) Hightemp();
  else digitalWrite(4, LOW);

}
```

Figure 37. Main code

Program always controls level, whenever the level exceeds 140 mm, the stopOperation function is called causing the green diode to turn on. If it is below 140 mm, the yellow diode is on. Any time the program checks the level value, it also checks temperature. Whenever it exceeds 50°C, the red diode turns on.

6.5. Tests

Tests have to be implemented to ensure that the product can fulfill our clients' needs. For our drying process we put a 5 l solution of algae and water in the tank, and at the end we want a 0,5 l concentrated solution. During this process we have to make sure that the temperature of the water doesn't raise over 50°C. To ensure that it works correctly and the temperature doesn't go over 50°C, it has to be tested and water put into the tank with a temperature over 50° degrees. In this case the thermometer should give a signal to the micro-controller that it should adjust the blinds and cool down the process.

The other test that has to be performed is by the end of the drying process. When the algae are dry enough they should contain less than 10 % of water. This means that at the end of the process we would have a 0,5 l solution left of the 5,0 l. When the process is ready (the solution is 0,5 l) the ultrasound level controller should give a signal to the micro-controller to stop the process, and close the blinds. These are the two main tests that our product needs to fulfill.

6.5.1. Ultrasound sensor test

In order to check the resolution of ultrasound sensor that we decided to use in our device, we conducted an experiment using plastic Tupperware tank, microcontroller arduino, ultrasound sensor and water. Because of the fact that the results from the first try were not precise enough, we needed to perform second experiment with the slightly changed code to have the output in millimetres, instead of centimetres.

6.5.1.1. The aim

The goal of the test was to check if the ultrasound sensor would be sensitive enough to sense the algae solution level in the solar algae dryer.

6.5.1.2. Preparation

To conduct the experiment, we needed: - SRF04 Ultrasonic Range Finder - Arduino microcontroller, connected to the computer with the Arduino environment installed on it - wiring system (connection of microcontroller with sensor) - the code for microcontroller to read the data given by ultrasonic sensor - plastic Tupperware tank - water - tape

6.5.1.3. Performing the experiment

We started with marking scale on the plastic tank. We decided to put the mark each 5mm. Then, we mounted as shown in Figure 38 below the sensor on the ruler on top of the tank in the position vertical to the tank bottom.



Figure 38. Mounting sensor horizontally to the bottom

The distance between bottom and ultrasonic sensor, so the height of the containers wall was 12 cm. The Arduino environment was also installed and operating code has been compiled. The measurement started with pouring water till obtaining 5mm on the scale and reading the value read by sensor. Microcontroller program returns the distance read from data given by sensor. Afterwards,

pouring the water was repeated every 5mm several times till reaching 30 mm. The pouring is presented in Figure 39.



Figure 39. Pouring water into the container

We tried to conduct the test also with the floating body inside the tank, to check if the sensor reads the distance more accurately shown in Figure 40.



Figure 40. Measurement with floating body inside the container

6.5.1.4. Results

The results of the experiment were gathered in the table presented below.

Table 16. Results of the experiment

Number of the measurement	Height of the liquid [mm]	Distance measured by sensor [cm] (1 st trial)	Distance measured by sensor [cm] (2 nd trial)	More precise [mm]
1	0	12	13	126
2	5	12,11	13	121
3	10	11	12	116
4	15	11,1	12	108
5	20	10	11	102
6	25	10,9	11	97
7	30	9	10	93

The numbers given in “distance measured by sensor” column are the most common readings of sensor. Hence, for instance 11/12 suggests that two most common values were 12 and 11. It’s good to mention that such readings were present for 0,5, 1 and 2,5 cm, so for medium values, which came as numbers between 12 and 11 or 11 and 10 or 10 and 9.

6.5.1.5. Observations

We noticed that it was necessary to put the sensor as best horizontally to the tank bottom as

possible. Any small difference in the angle of sensor position changed the sensor reading. It was also noticeable that sensor detected the surface of the water same well as the surface of floating body inside the container. The program returned only natural numbers of the sensor reading (so rounded to whole numbers) in cm. The readings in between the integers were noted by sensor in a way that program returned two closest numbers.

6.5.1.6. Conclusions

To sum up, we proved the usefulness of ultrasonic sensor in solar algae dryer. When applying it into the device we need to make sure that it is placed horizontally to the surface of algae solution. We also got to know that there is no need of using floating body in the solution, because sensor detects equally well water's level.

6.5.2. Charging algae test

6.5.2.1. Introduction

In our search to a way of separating the algae from the water we were wondering if the algae had a charge. To test that, we performed a charging test under the supervision of Maria Cristina Ribeiro.

6.5.2.1. Performance

First we had to determine the size of the particles, it was done by a method called Dynamic Light Scattering. After defining that we looked for the Zeta Potential. This was done buy a method called Laser Doppler Electrophoresis. At the first attempt we could not determine it, but when we diluted the solution, we could. We did all these test for every kind of algae we need to dry and we did them three times each. After the tests we could conclude that the algae have a negative charge (see column six) and that this could be used as an advantage. All the exact results can be seen in Table 17.

Table 17. Charging test results

Record	Type	Sample Name	Measurement Date and Time	T °C	ZP mV	Mob $\mu\text{mcm/Vs}$	Cond mS/cm
4	Zeta	SO 1	12.04.2013 16:10:43	25	-8,17	-0,6403	1,37
5	Zeta	SO 2	12.04.2013 16:11:44	25	-9,85	-0,7718	1,44
6	Zeta	SO 3	12.04.2013 16:12:41	25	-12,5	-0,9837	1,48
10	Zeta	100x 1 SO	12.04.2013 16:37:51	25	-5,26	-0,4122	0,215
11	Zeta	100x 2 SO	12.04.2013 16:38:53	25	-10,2	-0,7976	0,216
12	Zeta	100x 3	12.04.2013 16:39:53	25	-10,1	-0,7922	0,218
13	Zeta	CS 1	12.04.2013 16:47:21	25	-10,3	-0,8091	1,34
14	Zeta	CS 2	12.04.2013 16:48:35	25	-12,4	-0,9706	1,44
15	Zeta	CS 3	12.04.2013 16:49:32	25	-12,7	-0,9934	1,47
16	Zeta	Hp 1	12.04.2013 17:08:28	25	-12,7	-0,9927	0,931
17	Zeta	Hp 2	12.04.2013 17:09:27	25	-13,7	-1,076	0,972
18	Zeta	Hp 3	12.04.2013 17:10:21	25	-15,7	-1,23	0,996
19	Zeta	Am 1	12.04.2013 17:15:51	25	-16,1	-1,258	18,6
20	Zeta	Am 2	12.04.2013 17:16:33	25	-17,4	-1,363	19,5
21	Zeta	Am 3	12.04.2013 17:17:10	25	-19	-1,487	20,1
22	Zeta	Cv 1	12.04.2013 17:20:35	25	-26	-2,034	2,34
23	Zeta	Cv 2	12.04.2013 17:21:33	25	-23,8	-1,869	2,55
24	Zeta	Cv 3	12.04.2013 17:22:28	25	-25,4	-1,991	2,65
Mean				25	-14,5	-1,137	4,32
Std Dev				0	5,88	0,4608	6,98



Figure 41. Charging test at INEB lab

After finding out that the algae were negatively charged we could make a charging test in the lab to see if we could attract them to one side of the tank.

At first we tried with two titanium electrodes but it created a current and oxidized, so we had to find another method. Then we built a capacitor, which is two charged plates, one positive and one negative, and between the plates and the algae there is a capacitor, in this case a plastic box. We charged the plates with a 12 V input and measured the density of the algae every half an hour. For measuring the density we used a spectrometer that is an instrument used to measure properties of light over a specific portion of the electromagnetic spectrum [43].

Table 18. Results from charging test with capacitor

Time	Density
10.00	0.385
10.30	0.412
11.00	0.359
11.30	0.350
12.30	0.340
13.00	0.314

The pictures below show the setup of the test.

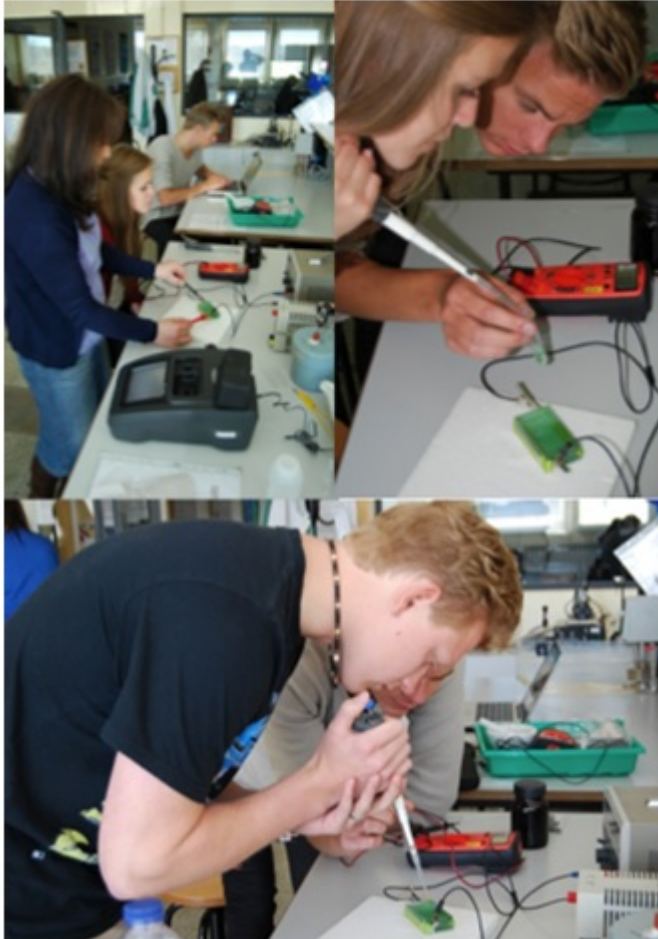

Figure 42. Charging test



Figure 43. Plastic box with algae in the beginning and end of the charging test

6.5.2.1. Results

The algae moved to the negative side of the box, but in the density measurements we could not get good results because the algae only got stuck to the side and floated up on the top. But when we measured the density in the end of the test and took a sample of the concentrated algae we got

1.074, which means the density had increased three times from 0.385 in the beginning.

6.6. Overheating of algae solution

As already mentioned, one of our major concerns is making sure the algal solution will not exceed 50 °C. And why is that? Algal biomass obtained from the process of drying is rich in many various beneficial components, such as among many others: lipids, pigments (carotenoids) or omega 3 acids. Their possible degradation is the reason for not to overheat the microalgae solution. According to Arief Widjaja in “Lipid production from microalgae as a promising candidate for biodiesel production” drying algae in high temperatures has deteriorating effect on lipid content [45]. The research made suggests that the decrease in lipid content may already be seen while drying in 60 °C. Even larger drop in lipid content may be noticed while drying in temperatures exceeding 60 °C. The gathered data is shown in Figure 44.

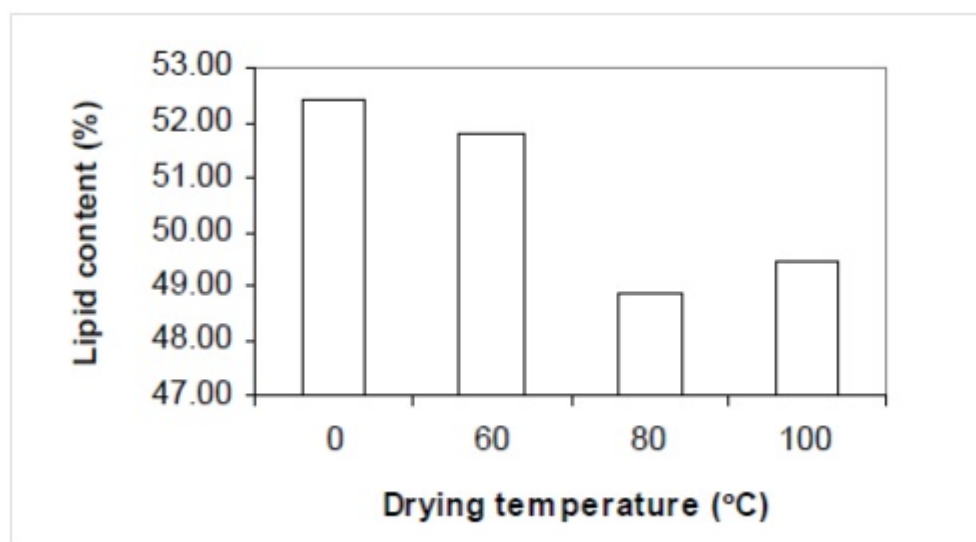

Figure 44. Lipid content at various drying methods [45]

As far as omega 3 fatty acids are concerned, they are easily oxidized when subjected to light, air or high temperatures. All the plants containing this kind of acids (for instance flax seeds) are treated at the temperatures not exceeding 40 °C in order not to destroy the natural structure or beneficial properties [44].

In accordance to group work: “Study on the microalgae pigments extraction process: Performance of microwave assisted extraction” from La Rochelle Univeristy, pigments such as carotenoids are prone to elevated temperatures. Degradation of most thermo sensitive molecules of carotenoids usually begins at the temperatures exceeding 60 °C, others like provitamin A carotenoids are less affected by high temperatures [45].

Hence, in order to be safe and taking into account most of the algal biomass components, it is wise not to exceed 50 °C as to be sure they are not harmed and able to be collected for further usage.

6.7. Best product performance

6.7.1. Evaporation factors

In order to check how fast the water should evaporate from our device we provided a table with proper variables, which are described later. Formula for evaporation rate is shown below:

$$E_r = \frac{(P_w - P_v)(0.089 + 0.0782V)}{Y} \left[\frac{kg}{s * m^2} \right]$$

Where: P_w - pressure exerted by water at the temperature of the air P_v - pressure of the vapour in the air, at the air temp. and pressure V - velocity of the air over the water Y - latent heat of vaporisation of water

To calculate the pressure exerted by the water at the temperature of the air we used formula from PN-EN ISO 13788: 2003. The temperature of the water will change according to the weather conditions and it can be changed manually in the table. The dimensions of the tank were also needed to examine from what area the water would evaporate. Afterwards we obtained the value of the evaporation rate.

Then we needed to check how much liquid would evaporate in one second. That is why the E_r value has been multiplied by the value of the area of the tanks bottom. To obtain the time in which four and a half kilograms would evaporate from the tank the following formula was used:

$$t = \frac{\text{weight of water}}{\text{amount of water evaporated in 1 sec} * 3600}$$

Then, there was just another facilitation added. Precisely, just a division of obtained time by twenty-four hours to get the approximate amount of days needed for the process.

6.7.2. Porto climate

In order to check the possible operation efficiency of the device, we gathered data concerning predicted weather and atmospheric conditions for the on-going year and the next. The following figures (45 and 46) present average heat index (in degrees Celsius) and solar radiation (in Watt). Figure 45. depicts the climate graph for Portugal including average temperature, relative humidity and wet days.

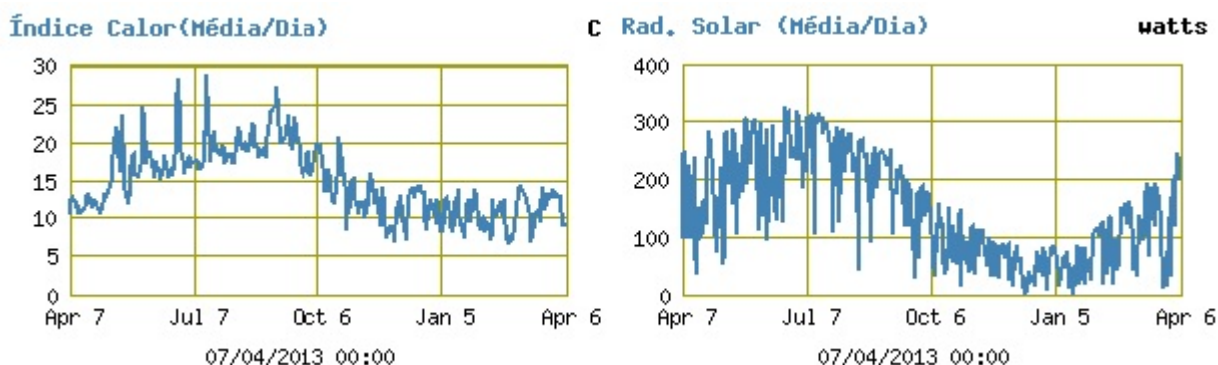

Figure 45. Solar radiation and Heat index diagrams [46]

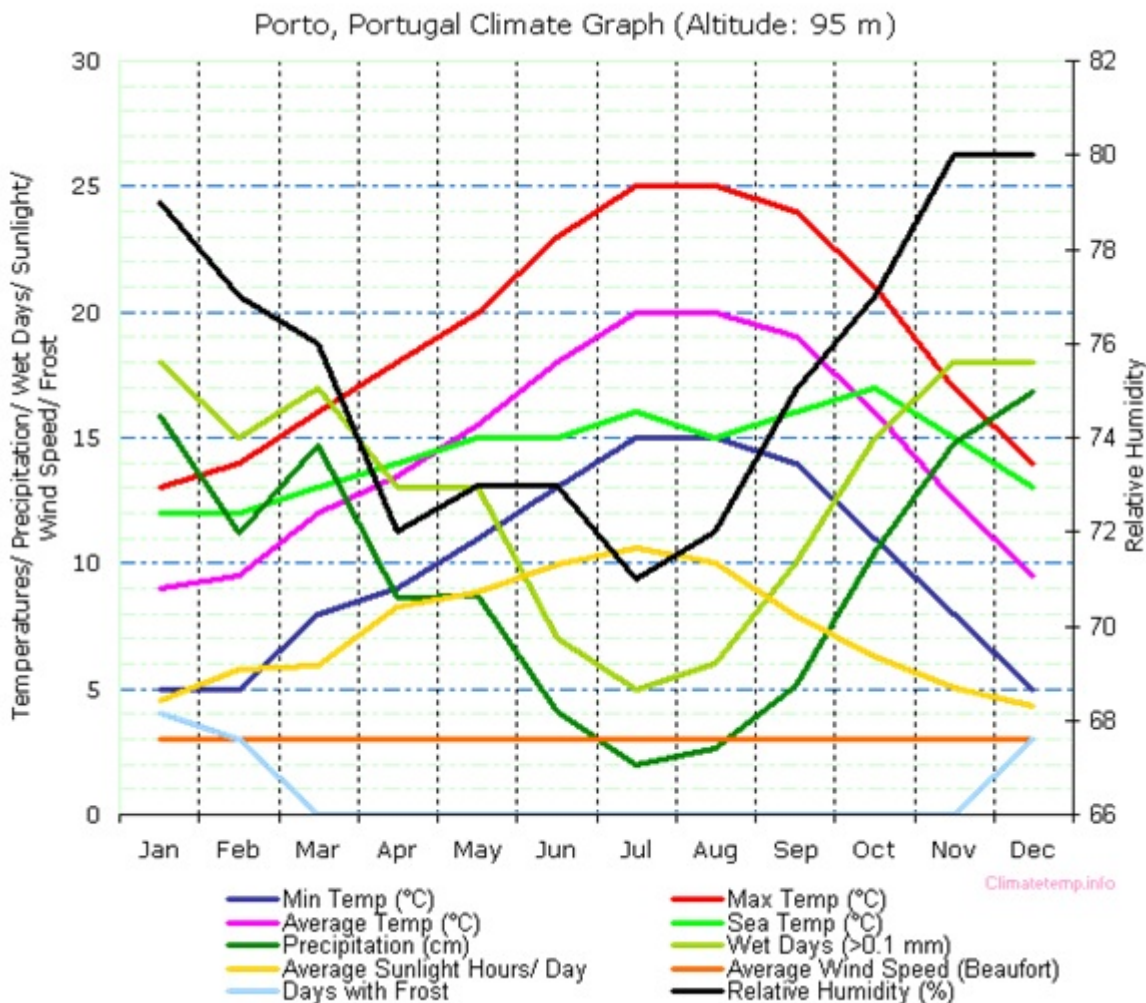

Figure 46. Climate graph for Porto [47]

The presented diagrams and graph make it possible to expect the best distiller performance from April till October. High solar radiation, followed by extensive heat index and significantly higher average temperatures are noted in the mentioned months. Those factors speed up evaporation process. What is more, relative humidity is also at its lowest ratings, which does not contribute to slowing down the whole process.

7. Conclusions

7.1. Discussion

To sum everything up, throughout this semester of EPS at ISEP in Porto we were working on Solar Algae Dryer. The device aimed on condensing algal solution through distilling process. In order to come to the final solution, we performed a thorough research concerning methods of drying, equipment used, competition on the market, according to our client's, so ISEP Chemistry laboratory needs.

Distilling process, which we chose to be the most energy efficient one, proved to work. The process takes long time, but since the time of the process was not our major concern, we are mostly relying on good weather conditions. We checked, what was very predictable, that the sunnier and warmer the

day is, the faster solution evaporates. It is also good to mention that completely closed container also plays a major role in the speed of evaporation. Due to that we needed to secure our container with rubber washers in order to prevent the water vapour from escaping. As we checked the tighter and air proof the tank was, the faster the process took place.

Unfortunately, we did not manage to install all the electrical appliances we aimed to have. We couldn't support our device with the autonomous solar power supply, thus we mounted only those parts that required 5 V only. Those are the most important components taking into account the potential threats towards algae - temperature control and level control system. Both of them assembled with indicating LEDs and Arduino Uno board were checked to work well. Whenever the temperature exceeded the limit, red diode turned on. Whenever the level of the liquid was small enough, the green diode representing the end of the process went on. Whenever the process was ongoing yellow diode was on as well. As already mentioned, we did not connect the blinds with stepper motor. Hence, it is necessary to operate the blinds manually whenever the need occurs. However, concerning product replication, the way of stepper motor connecting is described in former chapters of this report.

Throughout the process of product development, we were also submitted to analyse ethical, sustainable and marketing issues of our product. Each subject was thoroughly described taking into account among the others: marketing plan, market analysis, SWOT analysis, sustainable production, eco - efficiency, life cycle assessment, engineering code of ethics or liability.

All in all, we believe our project will serve well in the Chemistry lab drying out algae. As it is prototype, we truly hope that it will prove its usefulness and one day be replicated. In the end, we also reckon that it is suitable to be subjected to numerous test in order to check any possible future developments.

7.2. Future Developments

At the moment our product is not suitable for an extension. Many of the components, which are already used, fulfill the given tasks and adjust to the client's needs. Consequently, some parts are used, because they are ideal for prototyping. For the future we focus the research on improving the system for different applications.

For instance the project development shows that we can implement a charging solution to have easily set apart algae from the water. The idea is to put positively charged metal plate beneath the tank, which would attract negatively charged algae. But when we tried this the plates oxidised. So we tried an other option, a capacitor. There a positive charged plate on the outside of the tank attracts the algae. This worked and in order to find the best solution we tested different voltage as well as different types of algae. The results show that a lower voltage gives a lower impact. But the differences are just slight so that we can concentrate on the lower voltage and thanks to that use a weaker solar panel.

In addition, charged metal plate may also come in handy to automatize algae up removal process. Stuck to the surface algae will be easy to scratch or removed in other way. Another possibility is using special mechanical system. For example, pneumatic actuator or simply spring to lift up the container. Thanks to this algae could freely slide to the other container. The other idea is to combine solar algae dryer with water recovery system. The water obtained from dryer during distilling process may be recovered and reused afterwards. Yet, in order to do that special equipment would have to be installed.

Moreover, in the long perspective there might be a possibility to connect solar algae dryer to the bio-diesel production system and growing algae farm. Thanks to that, whole factory of the bio-diesel from the raw substrate to extracted product could be designed.

In general, getting more information about future clients requirements is really important in order to modify our product. Finally, the product may consist of a main solution with specific adaptations for different customer expectations.

Bibliography

- [1] Solix Biosystems. (2013, May) www.solixbiofuels.com. [Online]. <http://www.solixbiofuels.com>
- [2] Gicon. (2013, May) www.gicon.de. [Online]. [<http://www.gicon.de/geschaeftsbereiche/gte/bs.html>]
- [3] Gary Zeman. (2013, Mar.) www.hps.org. [Online]. <http://hps.org/hpspublications/articles/uv.html>
- [4] Jennie Allen. (2001, Sep.) www.earthobservatory.nasa.gov. [Online]. <http://earthobservatory.nasa.gov/Features/UVB/>
- [5] Wikipedia. (2013, Mar.) en.wikipedia.org. [Online]. <http://en.wikipedia.org/wiki/UV-B>
- [6] Aisglass. (2013, Mar.) www.aisglass.com. [Online]. http://www.aisglass.com/pvb_laminated.asp
- [7] InMotion. (2013, May) www.inmotion.pt. [Online]. [http://www.inmotion.pt/store/temperature-sensor-waterproof-\(ds18b20\)](http://www.inmotion.pt/store/temperature-sensor-waterproof-(ds18b20))
- [8] robot-electronics. (2013, May) www.robot-electronics.co.uk. [Online]. www.robot-electronics.co.uk/html/srf04tech.htm
- [9] Farnell. (2013, May) www.farnell.com. [Online]. <http://pt.farnell.com/multicomp/mc-sp15-gcs/solar-panel-15w-17-5v-296x507x18mm/dp/1852501>
- [10] Arduino. (2013, May) www.arduino.cc. [Online]. [<http://arduino.cc/en/Main/ArduinoBoardUno>]
- [11] Institute for energy and transport. (2013, May) <http://iet.jrc.ec.europa.eu>. [Online]. <http://iet.jrc.ec.europa.eu/energyefficiency/sites/energyefficiency/files/energy-efficiency-status-report-2012.pdf>
- [12] Farnell. (2013, May) uk.farnell.com. [Online]. <http://uk.farnell.com/ebm-papst/3312r/fan-humid-protect-92mm-12vdc/dp/1875264>
- [13] Batteryuniversity. (2013, May) www.batteryuniversity.com. [Online]. www.batteryuniversity.com
- [14] Die Presse. (2007, July) diepresse.com. [Online]. <http://diepresse.com/home/panorama/welt/315121/Weltweit-900-Millionen-Pkw-unterwegs->
- [15] Automotiveonline. (2011, May) www.automotiveonline.co.za. [Online]. http://de.wikipedia.org/wiki/Wirtschaftszahlen_zum_Automobil#cite_note-4
- [16] Lexikon der Nachhaltigkeit. (2012, Dec.) www.nachhaltigkeit.info. [Online]. http://www.nachhaltigkeit.info/artikel/klimagipfel_kopenhagen_2009_1320.htm

- [17] Ron Kirchner Umweltingenieur/ Fachjournalist. (2011, Sep.) www.biomasse-nutzung.de. [Online]. <http://www.biomasse-nutzung.de/kerosin-algenforschung-algentreibstoff-forschungsprojekt/>
- [18] European commission. (2013, May) [www.ec.europa.eu](http://ec.europa.eu). [Online]. http://ec.europa.eu/environment/eco-innovation/index_en.htm
- [19] European commission. (2013, May) [www.ec.europa.eu](http://ec.europa.eu). [Online]. http://ec.europa.eu/environment/eco-innovation/apply-funds/selection-criteria/index_en.htm
- [20] Algaelink N.V. (2013, May) <http://www.algaelink.com/>. [Online]. http://www.algaelink.com/joomla/index.php?option=com_content&view=article&id=8&Itemid=10
- [21] Achilles Group Limited. (2013, May) <http://www.achilles.com/en/>. [Online]. <http://www.achilles.com/en/>
- [22] Algaelink N.V. (2013, May) <http://www.algaelink.com/>. [Online]. <http://www.algaelink.com/>
- [23] Algae biomass summit. (2013, May) <http://www.algaebiomasssummit.org/>. [Online]. http://www.algaebiomasssummit.org/ema/DisplayPage.aspx?pagelD=Trade_Show_Map
- [24] Algae europe. (2013, May) <http://www.algaeurope.eu/>. [Online]. http://www.algaeurope.eu/en_lfm/index_alg.asp
- [25] International Algae congress. (2013, May) <http://www.algaecongress.com/>. [Online]. <http://www.algaecongress.com/page/3789>
- [26] vistasprint. (2013, May) <http://www.vistaprint.de/>. [Online]. [http://www.vistaprint.de/individuelle-broschueren.aspx?txi=15680&xnid=TopNav_Brochures+\(linked+item\)_Marketing+Materials_Marketing+Products&xnav=TopNav&GP=6%2f4%2f2013+12%3a09%3a41+PM&GPS=2858329252&GNF=0](http://www.vistaprint.de/individuelle-broschueren.aspx?txi=15680&xnid=TopNav_Brochures+(linked+item)_Marketing+Materials_Marketing+Products&xnav=TopNav&GP=6%2f4%2f2013+12%3a09%3a41+PM&GPS=2858329252&GNF=0)
- [27] Denic. (2013, May) <http://www.denic.de/>. [Online]. <http://www.denic.de/>
- [28] Oilgae. (2013, Apr.) www.oilgae.com. [Online]. <http://www.oilgae.com/>
- [29] Antonio A. Martins, Nidia S. Caetano Teresa M. Mata, "Microalgae for biodiesel production and other applications from "Renewable and Sustainable Energy Reviews", Elsevier, vol. 2, no. 12, pp. 15-18, May 2013. [30] Oxforddictionaries. (2013, Apr.) www.oxforddictionaries.com. [Online]. <http://www.oxforddictionaries.com>
- [31] Oxford University, World Commission on Environment and Development, "From One Earth to One World: An Overview", 1st ed., Oxford University Press, Ed. Oxford, United Kingdom: Oxford University Press, 1987. [32] Sustainabilitystore. (2013, Apr.) www.sustainabilitystore.com. [Online]. <http://www.sustainabilitystore.com/sustainable.html>
- [33] World Business Council for Sustainable Development. (200, Oct.) www.wbcsd.org. [Online]. http://www.wbcsd.org/web/publications/eco_efficiency_creating_more_value.pdf
- [34] Wisions. (2013, Apr.) www.wisions.net. [Online]. <http://www.wisions.net/technologyradar/technology/lead-acid-battery>
- [35] Mr. Paul Schneder. (2013, Apr.) www.p2sustainabilitylibrary.mil. [Online]. http://www.p2sustainabilitylibrary.mil/P2_Opportunity_Handbook/2_II_7.html

- [36] Umicore. (2013, Apr.) www.batteryrecycling.unicore.com. [Online]. <http://www.batteryrecycling.unicore.com/UBR/>
- [37] Sherrell R. Greene. (2013, Apr.) sustainableenergytoday.blogspot.pt. [Online]. <http://sustainableenergytoday.blogspot.pt/2010/01/carbon-footprint-of-electricity.html>
- [38] Solidworks. (2013, Apr.) www.solidworks.com. [Online]. http://www.solidworks.com/sustainability/design/2722_ENU_HTML.htm
- [39] Wikipedia. (2013, Apr.) en.wikipedia.org. [Online]. <http://en.wikipedia.org/wiki/Cyanoacrylate#Toxicity>
- [40] Wikipedia. (2013, Apr.) en.wikipedia.org. [Online]. <http://en.wikipedia.org/wiki/Plexiglas>
- [41] IEEE. (2013, Apr.) www.ieee.org. [Online]. <http://www.ieee.org/about/corporate/governance/p7-8.html>
- [42] thoughtstopaper. (2013, Apr.) www.thoughtstopaper.com. [Online]. <http://www.thoughtstopaper.com/knowledge/patenting-criteria-novel-non-obvious-useful.html>
- [43] Wikipedia. (2013, Apr.) en.wikipedia.org. [Online]. www.en.wikipedia.org/wiki/Spectrometer
- [44] Arief Widjaja, "Lipid production from microalgae as a promising candidate for biodiesel production," Makara, Teknologi, vol. 13, no. 1, pp. 47-51, Apr. 2009. [45] La Rochelle University, "Study on the microalgae pigments extraction process: Performance of microwave assisted extraction," La Rochelle University, Rochelle, Group work ISBN, 2013. [46] ISEP. (2013, Apr.) meteo.isep.ipp.pt. [Online]. <http://meteo.isep.ipp.pt/>
- [47] Climatemps Porto. (2013, Apr.) www.porto.climatemps.com. [Online]. <http://www.porto.climatemps.com/>
- [48] Applegate. (2013, May) www.applegate.co.uk. [Online]. <http://www.applegate.co.uk/listings/8cb09b806f9911e29d18005056822520.html>
- [49] United Nations Population Devison. (2010, June) <http://www.prb.org/>. [Online]. <http://www.google.de/imgres?um=1&hl=de&sa=N&biw=1323&bih=722&tbm=isch&tbnid=sp5pAjbHsbJd6M:&imgrefurl=http://www.prb.org/Publications/Datasheets/2012/world-population-data-sheet/fact-sheet-world-population.aspx&docid=Rej29xjxBsmsJM&imgurl=http://www.prb.org/images12/world-trends.gif&w=570&h=300&ei=vXVkJd-BB-Gp7Ab4rYG4Bg&zoom=1&iact=hc&vpx=227&vpy=448&dur=3280&hovh=163&hovw=310&tx=171&ty=130&page=2&tbnh=146&tbnw=278&start=25&ndsp=32&ved=1t:429,r:52,s:0,i:247>
- [50] Plexicril. (2013, Apr.) www.plexicril.pt. [Online]. <http://www.plexicril.pt>
- [51] Abhyantrii. (2013, Apr.) www.abhyantrii.in. [Online]. <http://www.abhyantrii.in/about-us/client/>
- [52] Dictionary.com. (2013, Apr.) dictionary.reference.com. [Online]. <http://dictionary.reference.com/>

Appendix

Arduino Uno datasheet [arduino_uno1.pdf](#)

Temperature sensor data sheet <http://datasheets.maximintegrated.com/en/ds/DS18B20.pdf>

Ultra sound level sensor data sheet [temp_sensor.pdf](#) [ultra_sound_sensor.pdf](#)

Fan data sheet [fan_data_sheet.pdf](#)

Stepper motor data sheet [y129.pdf](#)

Motor driver datasheet [l298-2.pdf](#)

Battery datasheet [battery.pdf](#)

Switch on/off datasheet [switch1.pdf](#)

2D technical drawing of the tank [dimensions.pdf](#)

Cutting plexiglass sketch [dimensions1.pdf](#)

Excel file to calculate the speed of evaporation in the tank in different conditions [evaporation_factors-eng.xlsx](#)

From:

<https://www.eps2013-wiki1.dee.isep.ipp.pt/> - **EPS2013-wiki1**

Permanent link:

<https://www.eps2013-wiki1.dee.isep.ipp.pt/doku.php?id=report>

Last update: **2013/06/22 19:49**

